



久尹股份有限公司  
JOYIN CO.,LTD.

# NTC Thermistor



IATF TS16949 / ISO 9001 / ISO14001

# 目錄

# CONTENTS

<b>Inrush Current Limiting Devices</b>	1 - 3
■ NTC POWER Thermistor JNR series -----	4 - 11
 <b>Temperature compensation and Temperature measurement</b>	12-13
■ NTC Sensor STD. JCR03 series -----	14-17
■ NTC Sensor STD. JCR05 series -----	18-22
■ NTC Sensor Specialty JSR series -----	23-25
■ NTC Sensor Specialty JTD series -----	26-28
■ NTC Sensor Specialty JFR series -----	29-31
■ NTC Sensor Specialty JAT series -----	32-34
■ NTC Sensor Specialty JAS series -----	35-38
■ NTC SMD JSN series -----	39-42

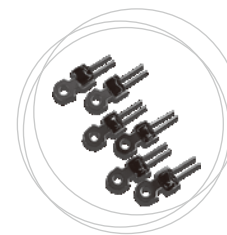
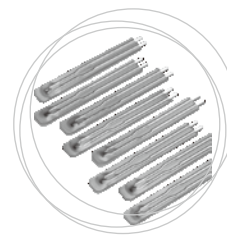
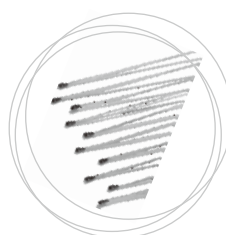
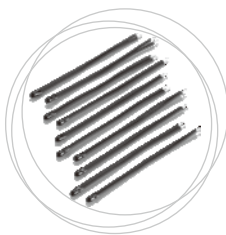
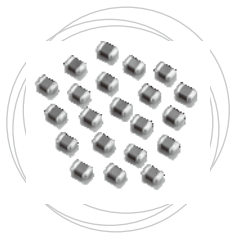

# NTC Thermistor – Inrush Current Limiting Devices

## Application Instruction

### Inrush current limiter

In electronic circuit which contains capacitors, filament bulbs, fluorescent lamp inverters and heaters, etc., will generate a inrush current with several ten times beyond the steady state current when it switch on. The zero-power resistance value of NTC is useful to suppress the inrush current and keep the circuit work stable.

A typical application of ICL devices( Fig. A ) The indicated in Fig. B is illustrates the ICL ( Inrush Current Limiting ) function.

### 浪湧電流抑制

在含有電容、燈絲燈泡、螢光燈整流器與加熱器..等電子電路中,在開關閉合的瞬間會產生一個比正常工作電流高出數十倍的浪湧電流,利用NTC熱敏電阻的零功率電阻值來抑制開機瞬間的浪湧電流不致於過大且不影響工作電流而使迴路正常工作。如下圖(A)。

AC電路-- A1 或 A2 與 DC電路 -- D1 或 D2 擺放位置,如下圖(B)。

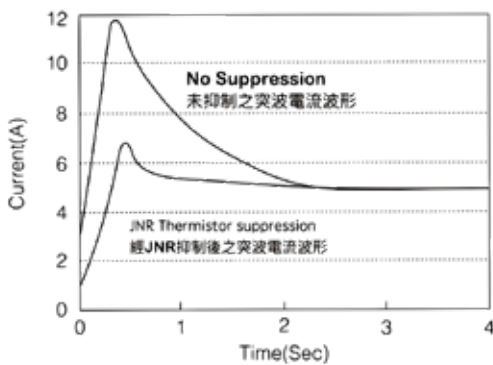

Fig A

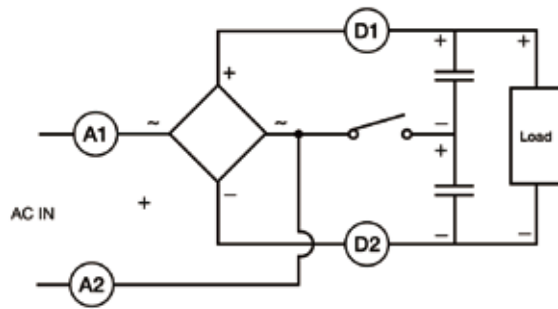

Fig B

## NTC Parameter Definition

### Rated Zero-Power Resistance (R25)

The resistance value measured at 25 °C ambient temperature.

### Material constant (β)

The comparison value of the resistances of a thermistor at a certain temperature and an other different temperature, it's calculated by the following formula and expressed in terms of the degrees Kelvin.

### 額定零功率電阻 (R25)

在特定溫度25°C下測得的熱敏電阻直流電阻值，也稱為零功率電阻。

### 材料常數(β)

NTC熱敏電阻在某一度之電阻與另一溫度之電阻的比較值，可由下面的公式計算得到並以卡氏溫度(K)表示

$$\beta = \ln(R1/R2) / (1/T1 - 1/T2)$$

$$T1 = 298.15^\circ\text{K}(+25^\circ\text{C}), T2 = 358.15^\circ\text{K}(+85^\circ\text{C}) \text{ for B25/85}$$

$$T1 = 298.15^\circ\text{K}(+25^\circ\text{C}), T2 = 323.15^\circ\text{K}(+50^\circ\text{C}) \text{ for B25/50}$$

### Maximum steady-state current (I<sub>max</sub>.)

(For JNR series only)

The maximum steady-state current is the rating of the maximum current, normally expressed in amperes(A), allowable to be conducted by an inrush limiting NTC Thermistor for an extended period of time.

### 最大穩態電流 ( I<sub>max</sub>.)

( For JNR series only)

NTC熱敏電阻能允許長時間通過的最大電流值,通常以安培(A)表示。

### Resistance at maximum current (R<sub>I<sub>max</sub></sub>.)

(For JNR series only)

The resistance at maximum current is the approximate resistance of an inrush current limiting thermistor, expressed in ohms(Ω), when it is conducting its rated maximum steady-state current.

### 最大穩態電流下的殘餘電阻 (R<sub>I<sub>max</sub></sub>.)

(For JNR series only)

NTC熱敏電阻通過額定最大穩定電流時的殘餘電阻，以歐姆(Ω)表示。

### Maximum Load Capacitance @AC240V

(For JNR series only )

The maximum capacitance is the maximum allowable capacitance of JNR series in power supply applications. This capacitance refers to the filter capacitance at the back end of the bridge rectifier. Generally, the recommended value of the JNR series should be greater than the value of the filter capacitance in the circuit

### 最大負載電容 @AC 240V

(For JNR series only)

此參數為JNR系列在電源應用時，可承受的最大負載電容值。此電容是指電源橋氏整流器後端的濾波電容，一般選用JNR系列的建議電容值須大於電路中的濾波電容值。

### Maximum Rated Power Consumption (P<sub>max</sub>.)

The maximum rated power consumption is the maximum power rating applied to the thermistor continuously at 25°C ambient temperature or the specified temperature in the specification. When the working temperature is below 0°C or over 25°C, the rating power should be decreased. (see Fig. C)

### 最大額定功耗 (P<sub>max</sub>.)

最大功率額定值是在25°C的環境溫度或詳細規範中規定的溫度下，長時間施加於熱敏電阻的最大功耗。工作溫度低於0°C或高於25°C時，額定功率應降低。如下圖C

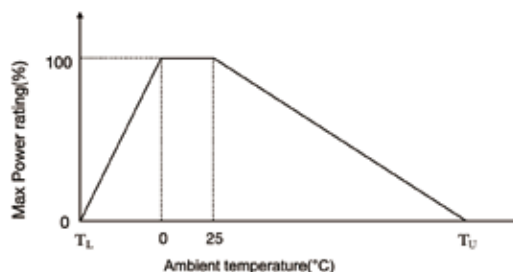

Note : T<sub>L</sub> = Minimum operating temperature(°C)  
T<sub>U</sub> = Maximum operating temperature(°C)

Fig C

For example :

Ambient temperature(T<sub>a</sub>)=55°C

Maximum operating temperature(T<sub>u</sub>)=200°C

$P_{Ta} = (T_u - T_a) / (T_u - 25) \times P_{max} = 82\% P_{max}$

### Thermal dissipation coefficient ( $\delta$ )

The thermal dissipation coefficient is ratio, it is expressed in  $mW/^{\circ}C$ , at a specified ambient temperature, of a change in power dissipation in a thermistor to the resultant body temperature change. (It can be expressed by the formula:  $\delta=V*I/\Delta T$ )

### 熱散逸係數( $\delta$ )

在一特定的環境溫度下，熱敏電阻電功率消耗對本體溫度變化量的比值，通常以 $mW/^{\circ}C$ 表示。 $(\delta=V*I/\Delta T)$

### Thermal time constant ( $\tau$ )

The thermal time constant is the time required for a thermistor to reach 63.2% of the difference between its initial and final body temperature when subjected to a step function change in ambient temperature under zero-power condition and is normally expressed in second. (See Fig.D)

Remark: the smaller the product volume is, the smaller the heat capacity and the faster the response.

### 熱時常數( $\tau$ )

在零功率情況下，當週圍溫度成步級函數變化後，其本體溫度之變化達到最初溫度與最終溫度差之63.2%時所需的時間，單位為秒數(Sec.) 表示。如下圖D。  
附註：產品體積越小，熱容量越小，響應越快。

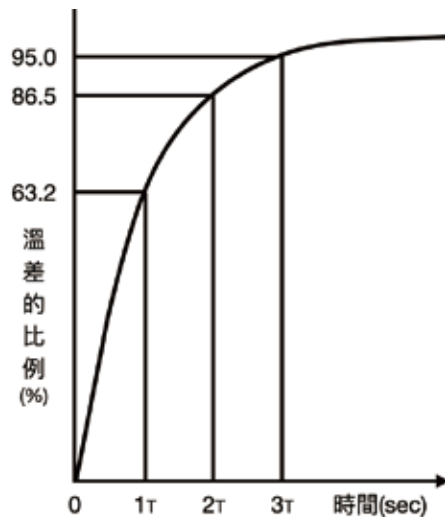

Fig D

### Operating temperature range

Ambient temperature range for thermistor's continuous operate at zero rated power. The defined maximum and minimum operating temperatures are specified in each series.

### 工作溫度範圍

熱敏電阻器能長時間工作在零功率的環境範圍。定義最大值和最小值標示在各系列規格表中。

# NTC POWER Thermistor JNR series

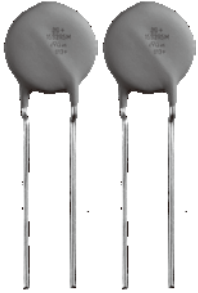

## Features

RoHS / Halogen-Free (HF) compliant  
 Body size : Ø5mm ~ Ø25mm  
 Highly stable electrical characteristics  
 Coating material flame retardant to UL 94V-0  
 Wide resistance range  
 Agency recognition : UL / TUV / CQC

符合RoHS / Halogen-Free (HF)規範  
 尺寸：Ø5mm ~ Ø25mm  
 電氣特性穩定性高  
 塗裝材料符合UL94V-0規範  
 電阻範圍廣  
 安規認證：UL / TUV / CQC

## Applications

Home appliances  
 Office automation  
 Switch mode power supplies  
 Adapters  
 Lighting driver

家電  
 OA 設備  
 開關模式電源  
 適配器  
 照明電源

## How to Order

Part Number Code														
1	2	3	4	5	6	7	8	9	10	11	12	13	14	15
J	N	R	1	0	S	1	0	0	L	8	5	P	U	5
①			②			③			④	⑤	⑥	⑦	⑧	

①	Product Type	JNR series	④	Tolerance of R25	L = ±15% M = ±20%	⑦	Lead Style	P = Straight Lead Y = Vertical Kink Lead I = Inside Kink Lead E = Outside Kink Lead G = Winder Kink Lead
②	Body Size	05S = 5mm 08S = 8mm 10S = 10mm 15S = 15mm 20S = 20mm 25S = 25mm	⑤	Lead Diameter	6 = 0.6mm 8 = 0.8mm 1 = 1.0mm	⑧	Packaging	50 = L:5.0±1mm for Straight Lead or L1:5.0±0.5mm for Kink Lead U4 = L1:24mm for Bulk & Kink Lead U5 = L:25mm for Bulk & Straight Lead AW= H0:16mm for Ammo RY = H0:20mm for T/R
③	Resistance @ 25°C(R25)	2R5 = 2.5Ω 050 = 5Ω 100 = 10Ω 101 = 100Ω	⑥	Lead Spacing	5 = 5mm 7 = 7.5mm 1 = 10mm			

## Safety Certification

Standard NO	UL/CUL	TUV	CQC
	UL1434	EN 60539-1:2016	GB/T6663.1-2007
File NO	E171531	R50236285	CQC10001050816

## Structure and Dimension

Kinked Lead (Y Type)

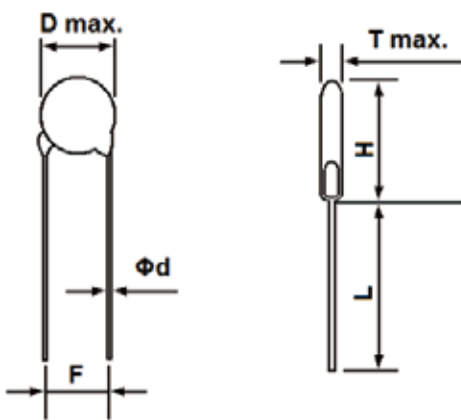

Straight Lead (P Type)

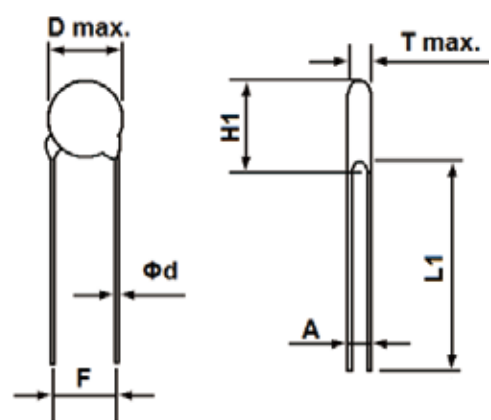



## Dimension Table

unit : mm

Diameter	Ø5mm	Ø8mm	Ø10mm	Ø13mm	Ø15mm	Ø20mm	Ø25mm
D max.	7.5	10.5	12.5	15.5	17.5	23.5	29.0
d ± 0.05	0.6/0.8	0.6/0.8	0.6/0.8	0.8/1.0	0.8/1.0	1.0	1.0
F ± 1.0	5.0	5.0	5.0/7.5	7.5	7.5/10	7.5/10	7.5/10
H max.	11.0	14.5	18.5	21.0	23.0	28.0	36.0
H1 max.	10.0	13.5	17.5	19.0	22.0	27.0	35.0
L min.	24.0	24.0	24.0	24.0	24.0	24.0	20.0
L1 min.	25.0	25.0	25.0	25.0	25.0	25.0	24.0
T max.	6.0	6.0	7.5	8.0	8.0	8.0	8.0



## Electrical Characteristics

Part No.	Resistance at 25°C	I <sub>max</sub>	R <sub>I</sub> max	Maximum Load Cap. AC240V	P <sub>max</sub> typical	Dissipation factor typical	Thermal time constant typical	Rated temperature	Safety Approvals
	(Ohms)	(Amps)	(Ω)	(μF)	(W)	δ(mW/°C)	(sec.)	T <sub>L</sub> ~T <sub>U</sub> °C	  
JNR05S030□	3.0	3.0	0.220	100	1.6	Approx. 13	Approx. 25	-40~+150	■ ■ ■
JNR05S040□	4.0	2.0	0.350	100	1.6	Approx. 13	Approx. 25	-40~+150	■ ■ ■
JNR05S050□	5.0	2.0	0.417	100	1.6	Approx. 13	Approx. 25	-40~+150	■ ■ ■
JNR05S05A□	5.0	3.0	0.200	100	1.6	Approx. 13	Approx. 25	-40~+150	■ ■ ■
JNR05S070□	7.0	1.2	0.554	100	1.6	Approx. 13	Approx. 25	-40~+150	■ ■ ■
JNR05S080□	8.0	1.0	0.911	68	1.6	Approx. 13	Approx. 25	-40~+150	■ ■ ■
JNR05S08A□	8.0	2.0	0.420	68	1.6	Approx. 13	Approx. 25	-40~+150	■ ■ ■
JNR05S100□	10	1.0	1.129	100	1.6	Approx. 13	Approx. 25	-40~+150	■ ■ ■
JNR05S10A□	10	2.0	0.675	100	1.6	Approx. 13	Approx. 25	-40~+150	■ ■ ■
JNR05S120□	12	1.0	1.188	68	1.6	Approx. 13	Approx. 25	-40~+150	■ ■ ■
JNR05S200□	20	0.3	5.600	100	1.6	Approx. 13	Approx. 25	-40~+150	■ ■ ■
JNR05S20A□	20	1.0	2.000	100	1.6	Approx. 13	Approx. 25	-40~+150	■ ■ ■
JNR08S2R5□	2.5	4.0	0.103	100	2.0	Approx. 14	Approx. 33	-40~+170	■ ■ ■
JNR08S030□	3.0	3.0	0.220	100	2.0	Approx. 14	Approx. 33	-40~+170	■ ■ ■
JNR08S040□	4.0	2.0	0.428	100	2.0	Approx. 14	Approx. 33	-40~+170	■ ■ ■
JNR08S4R7□	4.7	3.0	0.224	100	2.0	Approx. 14	Approx. 33	-40~+170	■ ■ ■
JNR08S050□	5.0	3.0	0.238	100	2.0	Approx. 14	Approx. 33	-40~+170	■ ■ ■
JNR08S060□	6.0	3.0	0.284	100	2.0	Approx. 14	Approx. 33	-40~+170	■ ■ ■
JNR08S070□	7.0	3.0	0.285	100	2.0	Approx. 14	Approx. 33	-40~+170	■ ■ ■
JNR08S080□	8.0	3.0	0.224	100	2.0	Approx. 14	Approx. 33	-40~+170	■ ■ ■
JNR08S100□	10	3.0	0.280	100	2.0	Approx. 14	Approx. 33	-40~+170	■ ■ ■
JNR08S150□	15	2.0	0.567	100	2.0	Approx. 14	Approx. 33	-40~+170	■ ■ ■
JNR08S180□	18	2.0	0.680	100	2.0	Approx. 14	Approx. 33	-40~+170	■ ■ ■
JNR08S200□	20	1.0	1.157	100	2.0	Approx. 14	Approx. 33	-40~+170	■ ■ ■
JNR08S220□	22	1.0	1.279	100	2.0	Approx. 14	Approx. 33	-40~+170	■ ■ ■
JNR08S300□	30	0.5	4.087	100	2.0	Approx. 14	Approx. 33	-40~+170	■ ■ ■
JNR10S1R0□	1.0	5.0	0.081	150	2.3	Approx. 16	Approx. 40	-40~+170	■ ■ ■
JNR10S1R3□	1.3	5.0	0.083	150	2.3	Approx. 16	Approx. 40	-40~+170	■ ■ ■
JNR10S1R5□	1.5	5.0	0.096	150	2.3	Approx. 16	Approx. 40	-40~+170	■ ■ ■
JNR10S2R0□	2.0	5.0	0.107	180	2.3	Approx. 16	Approx. 40	-40~+170	■ ■ ■
JNR10S2R5□	2.5	5.0	0.118	220	2.3	Approx. 16	Approx. 40	-40~+170	■ ■ ■
JNR10S030□	3.0	5.0	0.127	330	2.3	Approx. 16	Approx. 40	-40~+170	■ ■ ■
JNR10S040□	4.0	4.0	0.160	330	2.3	Approx. 16	Approx. 40	-40~+170	■ ■ ■
JNR10S050□	5.0	4.0	0.176	330	2.3	Approx. 16	Approx. 40	-40~+170	■ ■ ■
JNR10S060□	6.0	3.0	0.234	330	2.3	Approx. 16	Approx. 40	-40~+170	■ ■ ■
JNR10S6R8□	6.8	3.0	0.265	330	2.3	Approx. 16	Approx. 40	-40~+170	■ ■ ■
JNR10S070□	7.0	3.0	0.273	330	2.3	Approx. 16	Approx. 40	-40~+170	■ ■ ■
JNR10S080□	8.0	3.0	0.287	330	2.3	Approx. 16	Approx. 40	-40~+170	■ ■ ■
JNR10S100□	10	3.0	0.303	330	2.3	Approx. 16	Approx. 40	-40~+170	■ ■ ■
JNR10S120□	12	3.0	0.318	330	2.3	Approx. 16	Approx. 40	-40~+170	■ ■ ■
JNR10S130□	13	3.0	0.345	330	2.3	Approx. 16	Approx. 40	-40~+170	■ ■ ■
JNR10S150□	15	2.5	0.407	330	2.3	Approx. 16	Approx. 40	-40~+170	■ ■ ■
JNR10S160□	16	2.5	0.410	330	2.3	Approx. 16	Approx. 40	-40~+170	■ ■ ■
JNR10S200□	20	2.0	0.576	330	2.3	Approx. 16	Approx. 40	-40~+170	■ ■ ■
JNR10S220□	22	2.0	0.586	150	2.3	Approx. 16	Approx. 40	-40~+170	■ ■ ■
JNR10S250□	25	2.0	0.595	330	2.3	Approx. 16	Approx. 40	-40~+170	■ ■ ■
JNR10S300□	30	2.0	0.714	330	2.3	Approx. 16	Approx. 40	-40~+170	■ ■ ■
JNR10S470□	47	2.0	0.795	330	2.3	Approx. 16	Approx. 40	-40~+170	■ ■ ■
JNR10S500□	50	2.0	0.801	330	2.3	Approx. 16	Approx. 40	-40~+170	■ ■ ■
JNR10S800□	80	1.0	2.217	390	2.3	Approx. 16	Approx. 40	-40~+170	■ ■ ■
JNR10S101□	100	1.0	2.275	220	2.3	Approx. 16	Approx. 40	-40~+170	■ ■ ■
JNR10S121□	120	1.0	2.693	390	2.3	Approx. 16	Approx. 40	-40~+170	■ ■ ■

Note : □ = Tolerance of R25 (L = ±15% , M = ±20%)







## Electrical Characteristics

Part No.	Resistance at 25°C	I <sub>max</sub>	R <sub>I</sub> max	Maximum Load Cap. AC240V	P <sub>max</sub> typical	Dissipation factor typical	Thermal time constant typical	Rated temperature	Safety Approvals
	(Ohms)	(Amps)	(Ω)	(μF)	(W)	δ(mW/°C)	(sec.)	T <sub>L</sub> ~T <sub>U</sub> °C	
JNR13S1R0□	1.0	7.0	0.042	330	3.2	Approx. 18	Approx. 60	-40~+200	■ ■ ■
JNR13S1R3□	1.3	7.0	0.067	330	3.2	Approx. 18	Approx. 60	-40~+200	■ ■ ■
JNR13S2R0□	2.0	5.0	0.090	330	3.2	Approx. 18	Approx. 60	-40~+200	■ ■ ■
JNR13S2R5□	2.5	6.0	0.096	330	3.2	Approx. 18	Approx. 60	-40~+200	■ ■ ■
JNR13S030□	3.0	6.0	0.104	330	3.2	Approx. 18	Approx. 60	-40~+200	■ ■ ■
JNR13S040□	4.0	5.0	0.124	330	3.2	Approx. 18	Approx. 60	-40~+200	■ ■ ■
JNR13S4R7□	4.7	5.0	0.146	330	3.2	Approx. 18	Approx. 60	-40~+200	■ ■ ■
JNR13S050□	5.0	5.0	0.155	330	3.2	Approx. 18	Approx. 60	-40~+200	■ ■ ■
JNR13S060□	6.0	5.0	0.180	330	3.2	Approx. 18	Approx. 60	-40~+200	■ ■ ■
JNR13S070□	7.0	4.0	0.184	330	3.2	Approx. 18	Approx. 60	-40~+200	■ ■ ■
JNR13S080□	8.0	4.0	0.206	330	3.2	Approx. 18	Approx. 60	-40~+200	■ ■ ■
JNR13S100□	10	5.0	0.129	330	3.2	Approx. 18	Approx. 60	-40~+200	■ ■ ■
JNR13S120□	12	4.0	0.210	560	3.2	Approx. 18	Approx. 60	-40~+200	■ ■ ■
JNR13S150□	15	3.0	0.317	560	3.2	Approx. 18	Approx. 60	-40~+200	■ ■ ■
JNR13S160□	16	3.0	0.338	560	3.2	Approx. 18	Approx. 60	-40~+200	■ ■ ■
JNR13S180□	18	3.0	0.360	560	3.2	Approx. 18	Approx. 60	-40~+200	■ ■ ■
JNR13S200□	20	2.8	0.400	470	3.2	Approx. 18	Approx. 60	-40~+200	■ ■ ■
JNR13S250□	25	2.0	0.763	560	3.2	Approx. 18	Approx. 60	-40~+200	■ ■ ■
JNR13S500□	50	2.0	0.636	560	3.2	Approx. 18	Approx. 60	-40~+200	■ ■ ■
JNR15S0R7□	0.7	8.0	0.027	470	3.7	Approx. 21	Approx. 80	-40~+200	■ ■ ■
JNR15S1R0□	1.0	8.0	0.038	470	3.7	Approx. 21	Approx. 80	-40~+200	■ ■ ■
JNR15S1R3□	1.3	8.0	0.054	470	3.7	Approx. 21	Approx. 80	-40~+200	■ ■ ■
JNR15S1R5□	1.5	8.0	0.058	470	3.7	Approx. 21	Approx. 80	-40~+200	■ ■ ■
JNR15S2R0□	2.0	8.0	0.077	470	3.7	Approx. 21	Approx. 80	-40~+200	■ ■ ■
JNR15S2R5□	2.5	8.0	0.074	470	3.7	Approx. 21	Approx. 80	-40~+200	■ ■ ■
JNR15S030□	3.0	7.0	0.095	470	3.7	Approx. 21	Approx. 80	-40~+200	■ ■ ■
JNR15S040□	4.0	6.0	0.106	470	3.7	Approx. 21	Approx. 80	-40~+200	■ ■ ■
JNR15S4R7□	4.7	6.0	0.108	470	3.7	Approx. 21	Approx. 80	-40~+200	■ ■ ■
JNR15S050□	5.0	6.0	0.111	470	3.7	Approx. 21	Approx. 80	-40~+200	■ ■ ■
JNR15S060□	6.0	6.0	0.117	680	3.7	Approx. 21	Approx. 80	-40~+200	■ ■ ■
JNR15S070□	7.0	6.0	0.122	680	3.7	Approx. 21	Approx. 80	-40~+200	■ ■ ■
JNR15S080□	8.0	6.0	0.126	680	3.7	Approx. 21	Approx. 80	-40~+200	■ ■ ■
JNR15S100□	10	5.0	0.194	680	3.7	Approx. 21	Approx. 80	-40~+200	■ ■ ■
JNR15S120□	12	5.0	0.202	680	3.7	Approx. 21	Approx. 80	-40~+200	■ ■ ■
JNR15S150□	15	4.0	0.231	680	3.7	Approx. 21	Approx. 80	-40~+200	■ ■ ■
JNR15S160□	16	4.0	0.252	680	3.7	Approx. 21	Approx. 80	-40~+200	■ ■ ■
JNR15S180□	18	4.0	0.267	680	3.7	Approx. 21	Approx. 80	-40~+200	■ ■ ■
JNR15S200□	20	4.0	0.285	680	3.7	Approx. 21	Approx. 80	-40~+200	■ ■ ■
JNR15S220□	22	4.0	0.317	470	3.7	Approx. 21	Approx. 80	-40~+200	■ ■ ■
JNR15S250□	25	3.0	0.415	680	3.7	Approx. 21	Approx. 80	-40~+200	■ ■ ■
JNR15S300□	30	3.0	0.449	680	3.7	Approx. 21	Approx. 80	-40~+200	■ ■ ■
JNR15S330□	33	3.0	0.452	470	3.7	Approx. 21	Approx. 80	-40~+200	■ ■ ■
JNR15S400□	40	3.0	0.500	1000	3.7	Approx. 21	Approx. 80	-40~+200	■ ■ ■
JNR15S470□	47	3.0	0.524	1000	3.7	Approx. 21	Approx. 80	-40~+200	■ ■ ■
JNR15S800□	80	2.5	0.699	680	3.7	Approx. 21	Approx. 80	-40~+200	■ ■ ■
JNR15S121□	120	2.0	1.042	1000	3.7	Approx. 21	Approx. 80	-40~+200	■ ■ ■
JNR15S221□	220	1.0	3.455	1500	3.7	Approx. 21	Approx. 80	-40~+200	■ ■ ■

Note : □ = Tolerance of R25 (L = ±15% , M = ±20%)

## Electrical Characteristics

Part No.	Resistance at 25°C	I <sub>max</sub>	R <sub>I</sub> max	Maximum Load Cap. AC240V	P <sub>max</sub> typical	Dissipation factor typical	Thermal time constant typical	Rated temperature	Safety Approvals
	(Ohms)	(Amps)	(Ω)	(μF)	(W)	δ(mW/°C)	(sec.)	T <sub>L</sub> ~T <sub>U</sub> °C	  
JNR20S0R7□	0.7	13.0	0.029	1000	4.9	Approx. 28	Approx. 110	-40~+200	■ ■ ■
JNR20S1R0□	1.0	13.0	0.037	1000	4.9	Approx. 28	Approx. 110	-40~+200	■ ■ ■
JNR20S1R3□	1.3	10.0	0.042	1000	4.9	Approx. 28	Approx. 110	-40~+200	■ ■ ■
JNR20S1R5□	1.5	10.5	0.042	1000	4.9	Approx. 28	Approx. 110	-40~+200	■ ■ ■
JNR20S2R0□	2.0	10.0	0.059	1000	4.9	Approx. 28	Approx. 110	-40~+200	■ ■ ■
JNR20S2R2□	2.2	9.5	0.066	1000	4.9	Approx. 28	Approx. 110	-40~+200	■ ■ ■
JNR20S2R5□	2.5	9.0	0.083	1000	4.9	Approx. 28	Approx. 110	-40~+200	■ ■ ■
JNR20S030□	3.0	8.5	0.076	1000	4.9	Approx. 28	Approx. 110	-40~+200	■ ■ ■
JNR20S040□	4.0	8.0	0.076	1000	4.9	Approx. 28	Approx. 110	-40~+200	■ ■ ■
JNR20S4R7□	4.7	7.5	0.116	1000	4.9	Approx. 28	Approx. 110	-40~+200	■ ■ ■
JNR20S050□	5.0	7.5	0.118	1000	4.9	Approx. 28	Approx. 110	-40~+200	■ ■ ■
JNR20S060□	6.0	7.0	0.12	1000	4.9	Approx. 28	Approx. 110	-40~+200	■ ■ ■
JNR20S6R8□	6.8	6.5	0.122	1000	4.9	Approx. 28	Approx. 110	-40~+200	■ ■ ■
JNR20S070□	7.0	6.5	0.124	1000	4.9	Approx. 28	Approx. 110	-40~+200	■ ■ ■
JNR20S080□	8.0	6.0	0.128	1000	4.9	Approx. 28	Approx. 110	-40~+200	■ ■ ■
JNR20S100□	10	6.0	0.135	1000	4.9	Approx. 28	Approx. 110	-40~+200	■ ■ ■
JNR20S120□	12	5.0	0.165	1000	4.9	Approx. 28	Approx. 110	-40~+200	■ ■ ■
JNR20S130□	13	5.0	0.179	1000	4.9	Approx. 28	Approx. 110	-40~+200	■ ■ ■
JNR20S150□	15	4.5	0.255	1000	4.9	Approx. 28	Approx. 110	-40~+200	■ ■ ■
JNR20S160□	16	4.5	0.263	1000	4.9	Approx. 28	Approx. 110	-40~+200	■ ■ ■
JNR20S180□	18	4.0	0.278	1000	4.9	Approx. 28	Approx. 110	-40~+200	■ ■ ■
JNR20S200□	20	4.0	0.308	1000	4.9	Approx. 28	Approx. 110	-40~+200	■ ■ ■
JNR20S121□	120	2.0	1.075	1500	4.9	Approx. 28	Approx. 110	-40~+200	■ ■ ■
JNR25S1R0□	1.0	15.0	0.034	1200	7.0	Approx. 30	Approx. 130	-40~+200	■ ■ ■
JNR25S1R5□	1.5	15.0	0.035	1200	7.0	Approx. 30	Approx. 130	-40~+200	■ ■ ■
JNR25S2R0□	2.0	14.5	0.036	1200	7.0	Approx. 30	Approx. 130	-40~+200	■ ■ ■
JNR25S2R5□	2.5	14.5	0.037	1200	7.0	Approx. 30	Approx. 130	-40~+200	■ ■ ■
JNR25S030□	3.0	14.5	0.038	1200	7.0	Approx. 30	Approx. 130	-40~+200	■ ■ ■
JNR25S040□	4.0	14.0	0.039	1200	7.0	Approx. 30	Approx. 130	-40~+200	■ ■ ■
JNR25S4R7□	4.7	13.0	0.04	1200	7.0	Approx. 30	Approx. 130	-40~+200	■ ■ ■
JNR25S050□	5.0	11.0	0.066	1200	7.0	Approx. 30	Approx. 130	-40~+200	■ ■ ■
JNR25S6R8□	6.8	10.5	0.07	1200	7.0	Approx. 30	Approx. 130	-40~+200	■ ■ ■
JNR25S070□	7.0	10.0	0.091	1200	7.0	Approx. 30	Approx. 130	-40~+200	■ ■ ■
JNR25S080□	8.0	9.0	0.096	1200	7.0	Approx. 30	Approx. 130	-40~+200	■ ■ ■
JNR25S100□	10	8.0	0.143	1200	7.0	Approx. 30	Approx. 130	-40~+200	■ ■ ■
JNR25S120□	12	7.5	0.165	1200	7.0	Approx. 30	Approx. 130	-40~+200	■ ■ ■
JNR25S150□	15	6.5	0.223	1200	7.0	Approx. 30	Approx. 130	-40~+200	■ ■ ■
JNR25S180□	18	5.5	0.234	1200	7.0	Approx. 30	Approx. 130	-40~+200	■ ■ ■
JNR25S200□	20	5.0	0.245	1200	7.0	Approx. 30	Approx. 130	-40~+200	■ ■ ■

Note : □ = Tolerance of R25 (L = ±15% , M = ±20%)



## Reliability-NTC Thermistor JNR

Item	Standard	Test condition	Specifications															
Tenile Strength of Terminals	IEC 60068-2-21	After gradually applying the load specified below and keeping the unit fixed for 10 ±1 sec. <table border="1"> <thead> <tr> <th>Terminal diameter (mm)</th> <th>Force (Kg)</th> </tr> </thead> <tbody> <tr> <td>0.5 &lt; d ≤ 0.8</td> <td>1.02</td> </tr> <tr> <td>0.8 &lt; d ≤ 1.25</td> <td>2.04</td> </tr> </tbody> </table>	Terminal diameter (mm)	Force (Kg)	0.5 < d ≤ 0.8	1.02	0.8 < d ≤ 1.25	2.04	No visible damage									
Terminal diameter (mm)	Force (Kg)																	
0.5 < d ≤ 0.8	1.02																	
0.8 < d ≤ 1.25	2.04																	
Bending Strength of Terminals	IEC 60068-2-21	The unit is secured with one terminal kept in vertical and the weight specified below is applied in the axial direction. The terminal is gradually bent by 90° in one direction, then 90° in the opposite direction, and again back to the original position. <table border="1"> <thead> <tr> <th>Terminal diameter (mm)</th> <th>Force (Kg)</th> </tr> </thead> <tbody> <tr> <td>0.5 &lt; d ≤ 0.8</td> <td>0.51</td> </tr> <tr> <td>0.8 &lt; d ≤ 1.25</td> <td>1.02</td> </tr> </tbody> </table>	Terminal diameter (mm)	Force (Kg)	0.5 < d ≤ 0.8	0.51	0.8 < d ≤ 1.25	1.02	No visible damage									
Terminal diameter (mm)	Force (Kg)																	
0.5 < d ≤ 0.8	0.51																	
0.8 < d ≤ 1.25	1.02																	
Solderability	IEC 60068-2-20	245±3°C, 3±0.3 sec	At least 95% of terminal electrode is covered by newsolder															
Resistance to soldering heat	IEC 60068-2-20	260±3°C, 10±1 sec	No visible damage △R25 ≤ ±10%															
High temperature storage	IEC 60068-2-2	Tmax±5°C, 1000±24hrs	No visible damage △R25 ≤ ±20%															
Damp Heat	IEC 60068-2-78	40±2°C, 90~95% RH, 1000±24hrs	No visible damage △R25 ≤ ±20%															
Rapid Change of Temperature	IEC 60068-2-14	The conditions shown below shall be repeated 5 cycles . <table border="1"> <thead> <tr> <th>Step</th> <th>Temperature (°C)</th> <th>Period (minutes)</th> </tr> </thead> <tbody> <tr> <td>1</td> <td>-40±5</td> <td>30±3</td> </tr> <tr> <td>2</td> <td>Room temperature</td> <td>5±3</td> </tr> <tr> <td>3</td> <td>50/170/200±5</td> <td>30±3</td> </tr> <tr> <td>4</td> <td>Room temperature</td> <td>5±3</td> </tr> </tbody> </table>	Step	Temperature (°C)	Period (minutes)	1	-40±5	30±3	2	Room temperature	5±3	3	50/170/200±5	30±3	4	Room temperature	5±3	No visible damage △R25 ≤ ±20%
Step	Temperature (°C)	Period (minutes)																
1	-40±5	30±3																
2	Room temperature	5±3																
3	50/170/200±5	30±3																
4	Room temperature	5±3																
Room temperature Load	IEC 60539-1	25±5°C, I <sub>max</sub> , 1000±24hrs	No visible damage △R25 ≤ ±20%															
Endurance	Specification Standard	25±5°C, I <sub>max</sub> , CT, 1min ON / 5min OFFx1000 cycles. CT= Capacitance at 240Vac	No visible damage △R25 ≤ ±20%															
Insulation Resistance	MIL-STD-202 FMethod 302	1000V <sub>DC</sub> , 1min	No visible damage ≥ 500MΩ															

## Packaging

### Tape and Reel Dimensions

1/2" pitch

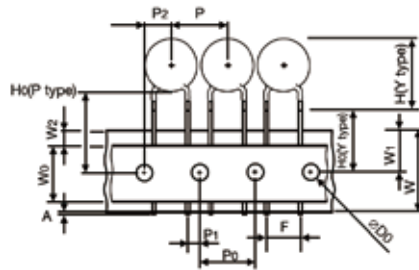

1.0" pitch

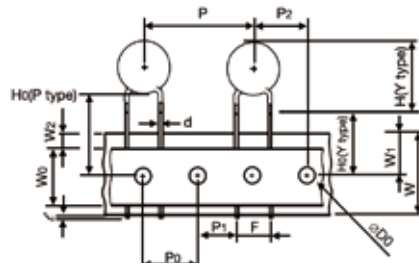



Symbols	Item	5/8/10mm	8/10/13/15/20mm	20/25mm
A	Cut out length	1.1 mm max.	1.1 mm max.	
H (Y type)	Height of Top	See H max. table		
H0(Y type)	Height to seating plane	16.0 ± 0.5 mm (*± 1.0 mm)	16.0 ± 0.5 mm (*± 1.0 mm)	
H0(P type)	Height of component from hole center	16.0 ~ 21.0 mm	16.0 ~ 21.0 mm	
Δh	Front to back deviation	0 ± 2.0 mm	0 ± 2.0 mm	
W	Carrier tape width	18 <sup>+1.0</sup> / <sub>-0.5</sub> mm	18 <sup>+1.0</sup> / <sub>-0.5</sub> mm	
W0	Hold down tape width	10.0 mm	12.0 mm	
W1	Sprocket hole position	9.0 <sup>+0.75</sup> / <sub>-0.5</sub> mm	9.0 <sup>+0.75</sup> / <sub>-0.5</sub> mm	
W2	Adhesive tape position	3.0 mm max.	3.0 mm max.	
F	Component lead spacing	5.0 ± 1.0 mm	7.5 ± 1.0 mm	10.0 ± 1.0 mm
P	Pitch of component	12.7 ± 1.0 mm	25.4 ± 1.0 mm	
P0	Sprocket hole pitch	12.7 ± 0.3 mm	12.7 ± 0.3 mm	
P1	Lead length from hole center to lead	3.85 ± 0.7 mm	8.95 ± 0.7 mm	7.7 ± 0.7 mm
P2	Length from hole center to disk center	6.35 ± 1.3 mm	12.7 ± 1.3 mm	
D0	Sprocket hole diameter	4.0 ± 0.2 mm	4.0 ± 0.2 mm	
d	Lead wire diameter	0.6 ± 0.05 mm	0.8 ± 0.05 mm	1.0 ± 0.05 mm
T	Disk thickness	See T max. table	See T max. table	
t1	Total thickness tape	0.7 ± 0.05 mm	0.7 ± 0.05 mm	
t2	Total thickness	1.6 mm max.	1.8 mm max.	

\* for manual line

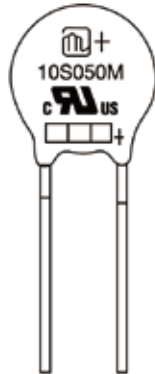
## Marking



 + : Taiwan Joyin  
 \* : Dongguan Joyin  
 + Internal code

## Packaging

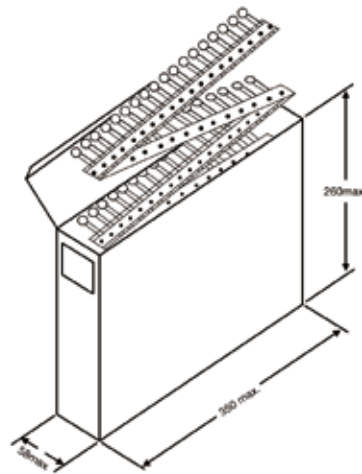
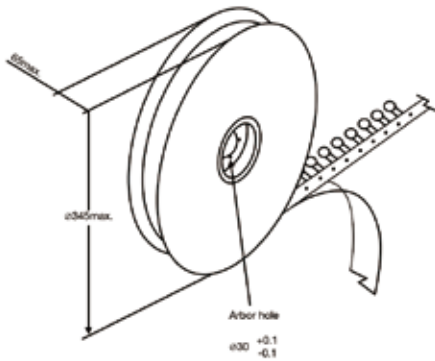

## Quantity per Packing Unit

Diameter Part No.	5mm	8mm	10mm	13mm	15mm	20mm	25mm
Bulk (box)	5000	4000	1500~2500	1000~2000	750~1500	750~1000	450~750
Reel	1500	1500	750~1000	500~1000	500~750	500~750	-
Ammo	1500	1000	750~1000	500~1000	500~750	-	-

Packaging	Bulk (Box)	Reel (5mm~10mm)	Reel (13mm~20mm)	Ammo (5mm,8mm)	Ammo (10mm~15mm)	Ammo (10mm~16mm)	Ammo (20mm)
Box size (mm)	290X155X110	350X350X108	350X350X74	330X240X46	343X210X52	343X260X52	343X220X58
Carton size (mm)	310X328X250	371X371X590	370X370X468	350X500X270	363X440X250	363X540X250	363X460X250
One carton with	4 Boxes	5 Boxes(10 reels)	6 Boxes(6 reels)	10 Boxes	8 Boxes	8 Boxes	8 Boxes

# NTC Thermistor – Temperature compensation & Temperature measurement

## Application Instruction

### Temperature measurement

NTC apply to the circuit of temperature measurement.  
Use NTC thermistor in one side of Wheatstone bridge.  
(see Fig.E)

### 溫度測量

NTC適用於溫度測量的電路，利用NTC熱敏電阻器來作為惠斯登平衡電橋中一邊。如下圖E。

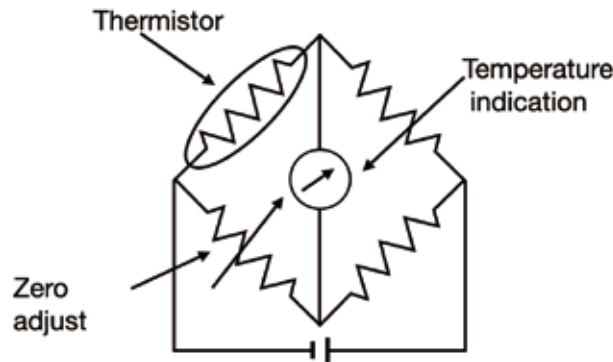

Fig E

### Temperature control

The following figure (Fig.F) shows the basic temperature control loop combined with the Thermistor and voltage comparator. The circuit can output the Thermistor into a high and low voltage signal corresponding to its resistance value by connected with a fixed resistor (in series or in parallel) and comparator.

### 溫度控制

圖(F)是熱敏電阻和電壓比較器組合而成的基本溫度控制迴路，該電路能將熱敏電阻對應其阻值的關係透過與固定電阻串並聯及比較器輸出成高低電壓信號，利用比較器的輸出電壓控制，如：場效電晶體等開關組件來達到控溫（控制風扇轉速達到過溫保護的目的）。

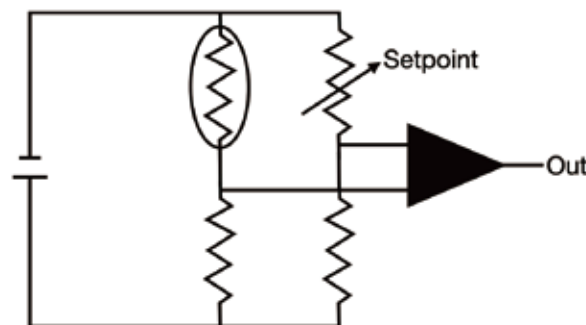

Fig F



### Temperature compensation

Many semiconductor ICs and components have positive temperature characteristics, and their resistance rises as the ambient temperature rises. In the actual application, the circuit will cause signal distortion, speaker sound deviation and other issues. As the NTC Thermistors have a negative temperature characteristic, this feature can be used to temperature compensate for components with positive temperature characteristics, allowing these components to maintain stable temperature characteristics over a wide temperature range. The Fig. G is an application example of NTC Thermistor applied for temperature compensation. The loop is composed of an NTC Thermistor (RT) and a matched linear resistor (RP) connected in parallel and then connected in series with a positive temperature characteristic resistor, and the total impedance keep stable over a wide temperature range.

### 溫度補償

許多半導體IC與零組件有正溫度特性，其阻值會隨著環境溫度升高而上升，在實際應用電路上會造成問題（如：會引起信號失真、揚聲器聲音走調..等）。由於NTC熱敏電阻具有負溫度特性，可利用此特性來對正溫度特性的組件進行溫度補償，讓這些組件在較寬的溫度範圍內保持溫度特性穩定。圖G是利用NTC熱敏電阻進行溫度補償案例說明 -- 用NTC熱敏電阻(RT)和匹配的線性電阻(RP)並聯後，再與具有正溫度特性的阻件(RS)串聯所組成的迴路，總阻抗在較寬的溫度範圍內可以保持穩定性。

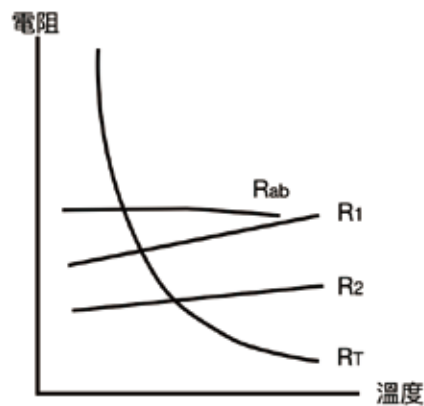
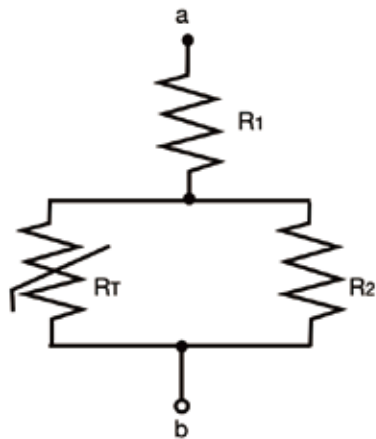

Fig G

# NTC Sensor STD. JCR03 series



## Features

RoHS / Halogen-Free (HF) compliant  
 Body size : Ø3mm  
 Operating temperature range : -40°C~+125°C  
 Wide resistance range  
 Qualified based on AEC-Q200  
 Agency recognition : UL / TUV

符合RoHS / Halogen-Free (HF)規範  
 尺寸 : Ø3mm  
 工作溫度範圍 : -40°C~+ 125°C  
 電阻範圍廣  
 符合 AEC-Q200  
 安規認證 : UL / TUV

## Applications

Home appliances  
 Office automation  
 Automotive  
 Switch mode power supplies  
 Adapters  
 Security

家電  
 OA 設備  
 汽車  
 開關模式電源  
 適配器  
 安防設備

## How to Order

Part Number Code																			
1	2	3	4	5	6	7	8	9	10	11	12	13	14	15	16	17	18	19	20
J	C	R	1	0	3	F	3	4	4	F	B	5	2	P	U	5	0	3	B
①			②			③	④			⑤	⑥	⑦	⑧	⑨	⑩		A		B

①	Product Type	JCR03 series	⑤	Tolerance of B Value	F = ±1% G = ±2% H = ±3% J = ±5%	⑨	Lead Style	E = Outside Kink Lead G = Winder Kink Lead
②	Zero Power Resistance @25°C (R25)	502 = 5KΩ 103 = 10KΩ 474 = 470KΩ	⑥	Definition of B Value	A = 25/50 B = 25/85	⑩	Packaging	U5 = L:25mm for Bulk AW= H0:16mm for Ammo
③	Tolerance of R25	F = ±1% G = ±2% H = ±3% J = ±5% K = ±10%	⑦	Lead Diameter	5 = 0.5 mm	A	Body Size	03 = 3 mm
④	B Value	344 = 3435 K 405 = 4050 K	⑧	Lead Spacing	2 = 2.5 mm 4 = 3.5 mm	B	Optional Suffix	Internal Control Code

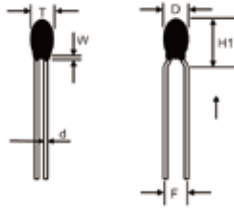

## Structure and Dimension





Unit in mm

Body Size	Dmax.	Tmax.	F±0.5	d±0.05	Wmax	H1max
Ø 3mm	4.0	3.5	2.5	0.5	3.0	10.0

## Electrical Characteristics

Part No.	Zero Power Resistance at 25°C	Tolerance of R25	B 25/50 Value	Tolerance of B Value	Dissipation Factor	Thermal Time Constant	Max. Power Rating at 25°C	Safety Approvals
	R 25 (Ω)	(± %)	( K )	(± %)	δ(mW/°C)	τ(sec.)	(mW)	 
JCR103X338YA	10,000	10,5,3,2,1	3380	5,3,2,1	Approx. 2.5	Approx. 18	150	■
JCR103X410YA	10,000	10,5,3,2,1	4100	5,3,2,1	Approx. 2.5	Approx. 18	150	■
JCR473X395YA	47,000	10,5,3,2,1	3950	5,3,2,1	Approx. 2.5	Approx. 18	150	■
JCR503X395YA	50,000	10,5,3,2,1	3950	5,3,2,1	Approx. 2.5	Approx. 18	150	■
JCR104X395YA	100,000	10,5,3,2,1	3950	5,3,2,1	Approx. 2.5	Approx. 18	150	
JCR104X425YA	100,000	10,5,3,2,1	4250	5,3,2,1	Approx. 2.5	Approx. 18	150	

Part No.	Zero Power Resistance at 25°C	Tolerance of R25	B 25/85 Value	Tolerance of B Value	Dissipation Factor	Thermal Time Constant	Max. Power Rating at 25°C	Safety Approvals
	R 25 (Ω)	(± %)	( K )	(± %)	δ(mW/°C)	τ(sec.)	(mW)	 
JCR102X360YB	1,000	10,5,3,2,1	3600	5,3,2,1	Approx. 2.5	Approx. 18	150	
JCR472X390YB	4,700	10,5,3,2,1	3900	5,3,2,1	Approx. 2.5	Approx. 18	150	
JCR502X345YB	5,000	10,5,3,2,1	3450	5,3,2,1	Approx. 2.5	Approx. 18	150	
JCR682X390YB	6,800	10,5,3,2,1	3900	5,3,2,1	Approx. 2.5	Approx. 18	150	
JCR103X344YB	10,000	10,5,3,2,1	3435	5,3,2,1	Approx. 2.5	Approx. 18	150	■ ■
JCR103X398YB	10,000	10,5,3,2,1	3980	5,3,2,1	Approx. 2.5	Approx. 18	150	■ ■
JCR333X398YB	33,000	10,5,3,2,1	3980	5,3,2,1	Approx. 2.5	Approx. 18	150	
JCR473X409YB	47,000	10,5,3,2,1	4090	5,3,2,1	Approx. 2.5	Approx. 18	150	■
JCR503X409YB	50,000	10,5,3,2,1	4090	5,3,2,1	Approx. 2.5	Approx. 18	150	■
JCR104X395YB	100,000	10,5,3,2,1	3950	5,3,2,1	Approx. 2.5	Approx. 18	150	■
JCR104X408YB	100,000	10,5,3,2,1	4080	5,3,2,1	Approx. 2.5	Approx. 18	150	■
JCR104X419YB	100,000	10,5,3,2,1	4190	5,3,2,1	Approx. 2.5	Approx. 18	150	■
JCR104X425YB	100,000	10,5,3,2,1	4250	5,3,2,1	Approx. 2.5	Approx. 18	150	
JCR104X436YB	100,000	10,5,3,2,1	4360	5,3,2,1	Approx. 2.5	Approx. 18	150	■
JCR204X406YB	200,000	10,5,3,2,1	4055	5,3,2,1	Approx. 2.5	Approx. 18	150	■
JCR334X398YB	330,000	10,5,3,2,1	3980	5,3,2,1	Approx. 2.5	Approx. 18	150	

※ X : R Tolerance, Y : B Value Tolerance

## Reliability-NTC Thermistor JCR

Item	Standard	Test condition	Specifications															
Terminal pull strength	IEC 60068-2-21	<p>Gradually applying the force specified and keeping the unit fixed for 10±1 sec</p> <table border="1"> <thead> <tr> <th>Terminal diameter (mm)</th> <th>Force (Kg)</th> </tr> </thead> <tbody> <tr> <td><math>d \leq 0.25\text{mm}</math></td> <td>1N (0.102Kg)</td> </tr> <tr> <td><math>0.25\text{mm} &lt; d \leq 0.35\text{mm}</math></td> <td>2.5N (0.255Kg)</td> </tr> <tr> <td><math>0.35\text{mm} &lt; d \leq 0.50\text{mm}</math></td> <td>5N (0.510Kg)</td> </tr> <tr> <td><math>0.50\text{mm} &lt; d \leq 0.80\text{mm}</math></td> <td>10N (1.02Kg)</td> </tr> </tbody> </table>	Terminal diameter (mm)	Force (Kg)	$d \leq 0.25\text{mm}$	1N (0.102Kg)	$0.25\text{mm} < d \leq 0.35\text{mm}$	2.5N (0.255Kg)	$0.35\text{mm} < d \leq 0.50\text{mm}$	5N (0.510Kg)	$0.50\text{mm} < d \leq 0.80\text{mm}$	10N (1.02Kg)	No visible damage					
Terminal diameter (mm)	Force (Kg)																	
$d \leq 0.25\text{mm}$	1N (0.102Kg)																	
$0.25\text{mm} < d \leq 0.35\text{mm}$	2.5N (0.255Kg)																	
$0.35\text{mm} < d \leq 0.50\text{mm}$	5N (0.510Kg)																	
$0.50\text{mm} < d \leq 0.80\text{mm}$	10N (1.02Kg)																	
Bending Strength of Terminals	IEC 60068-2-21	<p>Hold specimen and apply the force specified below to each lead. Bend the specimen to 90°, then return to the original position. Repeat the procedure in the opposite direction.</p> <table border="1"> <thead> <tr> <th>Terminal diameter (mm)</th> <th>Force (Kg)</th> </tr> </thead> <tbody> <tr> <td><math>d \leq 0.25\text{mm}</math></td> <td>0.5N (0.051Kg)</td> </tr> <tr> <td><math>0.25\text{mm} &lt; d \leq 0.35\text{mm}</math></td> <td>1.25N (0.128Kg)</td> </tr> <tr> <td><math>0.35\text{mm} &lt; d \leq 0.50\text{mm}</math></td> <td>2.5N (0.255Kg)</td> </tr> <tr> <td><math>0.50\text{mm} &lt; d \leq 0.80\text{mm}</math></td> <td>5N (0.510Kg)</td> </tr> </tbody> </table>	Terminal diameter (mm)	Force (Kg)	$d \leq 0.25\text{mm}$	0.5N (0.051Kg)	$0.25\text{mm} < d \leq 0.35\text{mm}$	1.25N (0.128Kg)	$0.35\text{mm} < d \leq 0.50\text{mm}$	2.5N (0.255Kg)	$0.50\text{mm} < d \leq 0.80\text{mm}$	5N (0.510Kg)	No visible damage					
Terminal diameter (mm)	Force (Kg)																	
$d \leq 0.25\text{mm}$	0.5N (0.051Kg)																	
$0.25\text{mm} < d \leq 0.35\text{mm}$	1.25N (0.128Kg)																	
$0.35\text{mm} < d \leq 0.50\text{mm}$	2.5N (0.255Kg)																	
$0.50\text{mm} < d \leq 0.80\text{mm}$	5N (0.510Kg)																	
Solderability	IEC 60068-2-20	245±3°C, 3±0.3 sec	At least 95% of terminal electrode is covered by new solder															
Resistance to soldering heat	IEC 60068-2-20	260±5°C, 10±1 sec	No visible damage △R25/R25 ≤ ±5%															
High temperature storage	IEC 60068-2-2	125±2°C, 1000hrs	No visible damage △R25/R25 ≤ ±5%															
Damp Heat Steady State	IEC 60068-2-78	40±2°C, 90~95% RH, 1000±24hrs	No visible damage △R25/R25 ≤ ±5%															
Rapid Change of Temperature	IEC 60068-2-14	<p>The conditions shown below shall be repeated 5 cycles.</p> <table border="1"> <thead> <tr> <th>Step</th> <th>Temperature (°C)</th> <th>Period (minutes)</th> </tr> </thead> <tbody> <tr> <td>1</td> <td>-40±5</td> <td>30±3</td> </tr> <tr> <td>2</td> <td>Room temperature</td> <td>5±3</td> </tr> <tr> <td>3</td> <td>125±5</td> <td>30±3</td> </tr> <tr> <td>4</td> <td>Room temperature</td> <td>5±3</td> </tr> </tbody> </table>	Step	Temperature (°C)	Period (minutes)	1	-40±5	30±3	2	Room temperature	5±3	3	125±5	30±3	4	Room temperature	5±3	No visible damage △R25/R25 ≤ ±5%
Step	Temperature (°C)	Period (minutes)																
1	-40±5	30±3																
2	Room temperature	5±3																
3	125±5	30±3																
4	Room temperature	5±3																
Life Test	IEC 60539-1 4.26.3	25±5°C, Pmax, 1000hrs	No visible damage △R25/R25 ≤ ±5%															

## Packaging

### Tape and Reel Dimensions

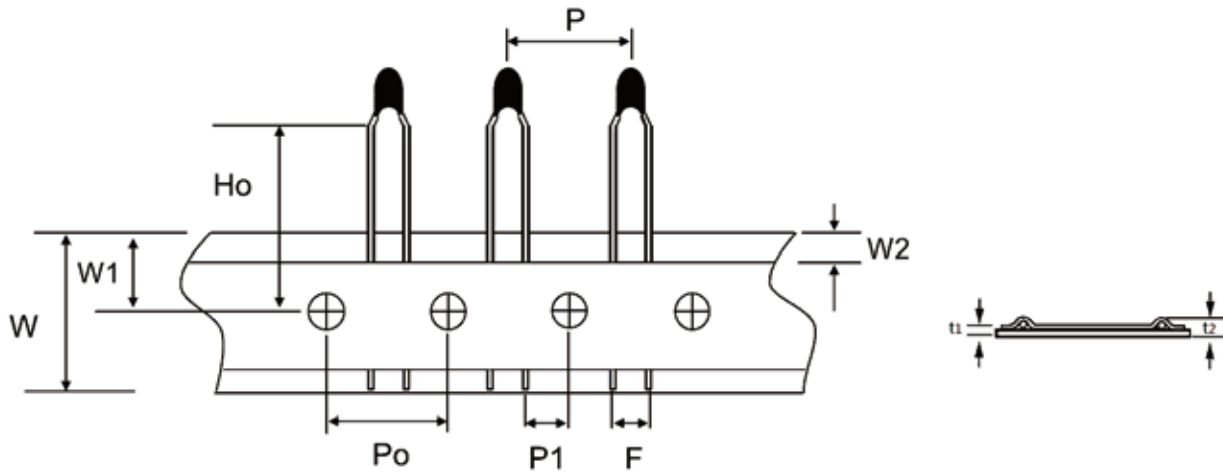

Unit in mm

Symbols	P	Po	P1	F	Ho	W	Wo	W1	W2	t1	t2
Nor.	12.7	12.7	5.1	2.5	18	18	12	9.0	2.0	0.6	1.2
Tol	±1.0	±0.3	±1.0	±0.5	±1.0	+1.0 -0.5	min	±0.5	max	±0.05	max

# NTC Sensor STD. JCR05 series



## Features

RoHS / Halogen-Free (HF) compliant  
 Body size : Ø5mm  
 Operating temperature range : -40°C~+125°C  
 Wide resistance range  
 Agency recognition : UL / TUV

符合RoHS / Halogen-Free (HF)規範  
 尺寸：Ø5mm  
 工作溫度範圍：-40°C~+ 125°C  
 電阻範圍廣  
 安規認證：UL / TUV

## Applications

Home appliances  
 Office automation  
 Automotive  
 Switch mode power supplies  
 Adapters  
 Security

家電  
 OA 設備  
 汽車  
 開關模式電源  
 適配器  
 安防設備

## How to Order

Part Number Code																			
1	2	3	4	5	6	7	8	9	10	11	12	13	14	15	16	17	18	19	20
J	C	R	1	0	3	F	3	4	4	F	B	5	2	P	U	5	0	5	Y
①			②			③	④			⑤	⑥	⑦	⑧	⑨	⑩		A		B

①	Product Type	JCR05 series	⑤	Tolerance of B Value	F = ±1% H = ±3% J = ±5%	⑨	Lead Style	E = Outside Kink Lead G = Winder Kink Lead P = Straight Lead
②	Zero Power Resistance @25°C (R25)	502 = 5KΩ 103 = 10KΩ 474 = 470KΩ	⑥	Definition of B Value	A = 25/50 B = 25/85	⑩	Packaging	U5 = L:25mm for Bulk AW = H0:16mm for Ammo
③	Tolerance of R25	F = ±1% H = ±3% J = ±5% K = ±10%	⑦	Lead Diameter	5 = 0.5 mm	A	Body Size	05 = 5 mm
④	B Value	344 = 3435 K 405 = 4050 K	⑧	Lead Spacing	2 = 2.5 mm 4 = 3.5 mm	B	Optional Suffix	Internal Control Code



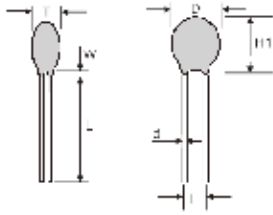

## Structure and Dimension





Unit in mm

Body Size	Dmax.	Tmax.	F±0.5	d±0.05	Wmax	H1max
Ø 5mm	6.0	3.5	2.5	0.5	3.0	8.0

## Electrical Characteristics

Part No.	Zero Power Resistance at 25°C	Tolerance of R25	B 25/50 Value	Tolerance of B Value	Dissipation Factor	Thermal Time Constant	Max. Power Rating at 25°C	Safety Approvals
	R 25 (Ω)	(± %)	( K )	(± %)	δ(mW/°C)	τ(sec.)	(mW)	 
JCR682X405YA	6,800	10,5,3,1	4050	5,3,1	Approx. 7.2	Approx. 18	450	■
JCR103X405YA	10,000	10,5,3,1	4050	5,3,1	Approx. 7.2	Approx. 18	450	■ ■
JCR103X410YA	100,000	10,5,3,1	4100	5,3,1	Approx. 7.2	Approx. 18	450	■
JCR104X440YA	100,000	10,5,3,1	4400	5,3,1	Approx. 7.2	Approx. 18	450	■ ■
JCR474X520YA	470,000	10,5,3,1	5200	5,3,1	Approx. 7.2	Approx. 18	450	■ ■

Part No.	Zero Power Resistance at 25°C	Tolerance of R25	B 25/85 Value	Tolerance of B Value	Dissipation Factor	Thermal Time Constant	Max. Power Rating at 25°C	Safety Approvals
	R 25 (Ω)	(± %)	( K )	(± %)	δ(mW/°C)	τ(sec.)	(mW)	 
JCR102X375YB	1,000	10,5,3,1	3750	5,3,1	Approx. 7.2	Approx. 18	450	
JCR202X385YB	2,000	10,5,3,1	3850	5,3,1	Approx. 7.2	Approx. 18	450	
JCR252X390YB	2,500	10,5,3,1	3900	5,3,1	Approx. 7.2	Approx. 18	450	
JCR332X390YB	3,000	10,5,3,1	3900	5,3,1	Approx. 7.2	Approx. 18	450	
JCR502X405YB	5,000	10,5,3,1	4050	5,3,1	Approx. 7.2	Approx. 18	450	
JCR303X430YB	30,000	10,5,3,1	4300	5,3,1	Approx. 7.2	Approx. 18	450	
JCR204X470YB	200,000	10,5,3,1	4700	5,3,1	Approx. 7.2	Approx. 18	450	
JCR224X500YB	220,000	10,5,3,1	5000	5,3,1	Approx. 7.2	Approx. 18	450	

※ X : R Tolerance, Y : B Value Tolerance

## Reliability-NTC Thermistor JCR

Item	Standard	Test condition	Specifications															
Terminal pull strength	IEC 60068-2-21	<p>Gradually applying the force specified and keeping the unit fixed for 10±1 sec.</p> <table border="1"> <thead> <tr> <th>Terminal diameter (mm)</th> <th>Force (Kg)</th> </tr> </thead> <tbody> <tr> <td><math>d \leq 0.25\text{mm}</math></td> <td>1N (0.102Kg)</td> </tr> <tr> <td><math>0.25\text{mm} &lt; d \leq 0.35\text{mm}</math></td> <td>2.5N (0.255Kg)</td> </tr> <tr> <td><math>0.35\text{mm} &lt; d \leq 0.50\text{mm}</math></td> <td>5N (0.510Kg)</td> </tr> <tr> <td><math>0.50\text{mm} &lt; d \leq 0.80\text{mm}</math></td> <td>10N (1.02Kg)</td> </tr> </tbody> </table>	Terminal diameter (mm)	Force (Kg)	$d \leq 0.25\text{mm}$	1N (0.102Kg)	$0.25\text{mm} < d \leq 0.35\text{mm}$	2.5N (0.255Kg)	$0.35\text{mm} < d \leq 0.50\text{mm}$	5N (0.510Kg)	$0.50\text{mm} < d \leq 0.80\text{mm}$	10N (1.02Kg)	No visible damage					
Terminal diameter (mm)	Force (Kg)																	
$d \leq 0.25\text{mm}$	1N (0.102Kg)																	
$0.25\text{mm} < d \leq 0.35\text{mm}$	2.5N (0.255Kg)																	
$0.35\text{mm} < d \leq 0.50\text{mm}$	5N (0.510Kg)																	
$0.50\text{mm} < d \leq 0.80\text{mm}$	10N (1.02Kg)																	
Bending Strength of Terminals	IEC 60068-2-21	<p>Hold specimen and apply the force specified below to each lead. Bend the specimen to 90°, then return to the original position. Repeat the procedure in the opposite direction.</p> <table border="1"> <thead> <tr> <th>Terminal diameter (mm)</th> <th>Force (Kg)</th> </tr> </thead> <tbody> <tr> <td><math>d \leq 0.25\text{mm}</math></td> <td>0.5N (0.051Kg)</td> </tr> <tr> <td><math>0.25\text{mm} &lt; d \leq 0.35\text{mm}</math></td> <td>1.25N (0.128Kg)</td> </tr> <tr> <td><math>0.35\text{mm} &lt; d \leq 0.50\text{mm}</math></td> <td>2.5N (0.255Kg)</td> </tr> <tr> <td><math>0.50\text{mm} &lt; d \leq 0.80\text{mm}</math></td> <td>5N (0.510Kg)</td> </tr> </tbody> </table>	Terminal diameter (mm)	Force (Kg)	$d \leq 0.25\text{mm}$	0.5N (0.051Kg)	$0.25\text{mm} < d \leq 0.35\text{mm}$	1.25N (0.128Kg)	$0.35\text{mm} < d \leq 0.50\text{mm}$	2.5N (0.255Kg)	$0.50\text{mm} < d \leq 0.80\text{mm}$	5N (0.510Kg)	No visible damage					
Terminal diameter (mm)	Force (Kg)																	
$d \leq 0.25\text{mm}$	0.5N (0.051Kg)																	
$0.25\text{mm} < d \leq 0.35\text{mm}$	1.25N (0.128Kg)																	
$0.35\text{mm} < d \leq 0.50\text{mm}$	2.5N (0.255Kg)																	
$0.50\text{mm} < d \leq 0.80\text{mm}$	5N (0.510Kg)																	
Solderability	IEC 60068-2-20	245±3°C, 3±0.3 sec	At least 95% of terminal electrode is covered by new solder															
Resistance to soldering heat	IEC 60068-2-20	260±5°C, 10±1 sec	No visible damage △R25/R25 ≤ ±5%															
High temperature storage	IEC 60068-2-2	125±2°C, 1000hrs	No visible damage △R25/R25 ≤ ±5%															
Damp Heat Steady State	IEC 60068-2-78	40±2°C, 90~95% RH, 1000±24hrs	No visible damage △R25/R25 ≤ ±5%															
Rapid Change of Temperature	IEC 60068-2-14	<p>The conditions shown below shall be repeated 5 cycles.</p> <table border="1"> <thead> <tr> <th>Step</th> <th>Temperature (°C)</th> <th>Period (minutes)</th> </tr> </thead> <tbody> <tr> <td>1</td> <td>-40±5</td> <td>30±3</td> </tr> <tr> <td>2</td> <td>Room temperature</td> <td>5±3</td> </tr> <tr> <td>3</td> <td>125±5</td> <td>30±3</td> </tr> <tr> <td>4</td> <td>Room temperature</td> <td>5±3</td> </tr> </tbody> </table>	Step	Temperature (°C)	Period (minutes)	1	-40±5	30±3	2	Room temperature	5±3	3	125±5	30±3	4	Room temperature	5±3	No visible damage △R25/R25 ≤ ±5%
Step	Temperature (°C)	Period (minutes)																
1	-40±5	30±3																
2	Room temperature	5±3																
3	125±5	30±3																
4	Room temperature	5±3																
Life Test	IEC 60539-1 4.26.3	25±5°C, Pmax, 1000hrs	No visible damage △R25/R25 ≤ ±5%															

## Marking

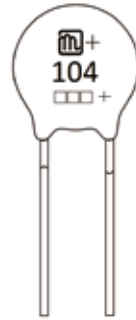

- ☐+: Taiwan Joyin
- ☐\*: Dongguan Joyin
- ☐☐+: Internal code

## Tape & Reel

1/2" pitch

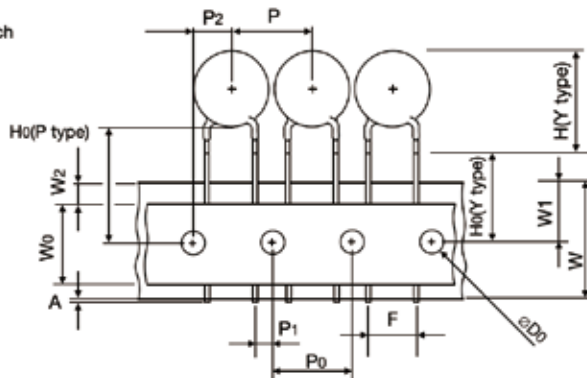

Symbols	Item	JCR05
I	Cut out length	1.1 mm max.
H0(P type)	Height of component from hole center	16.0 ~ 21.0 mm
Δh	Front to back deviation	0± 2.0 mm
W	Carrier tape width	18 <sup>+1</sup> / <sub>-5</sub> mm
W0	Hold down tape width	10.0 mm
W1	Sprocket hole position	9 <sup>+0.75</sup> / <sub>-0.5</sub> mm
W2	Adhesive tape position	3.0 mm max.
F	Component lead spacing	3.5±1.0 mm
P	Pitch of component	12.7 ± 1.0 mm
P0	Sprocket hole pitch	12.7 ± 0.3 mm
P1	Lead length from hole center to lead	4.6 ± 0.7 mm
P2	Length from hole center to disk center	6.35 ± 1.3 mm
D0	Sprocket hole diameter	4.0 ± 0.2 mm
d	Lead wire diameter	0.5± 0.05 mm
T	Disk thickness	3.5 mm max.
t1	Total thickness tape	0.7 ± 0.05 mm
t2	Total thickness	1.6 mm max.

## Packaging

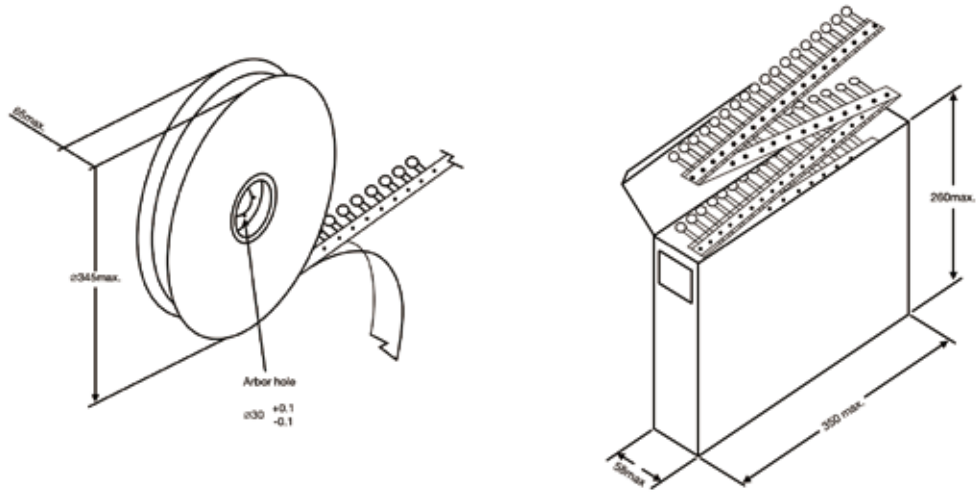

Packaging Diameter	Bulk (box)	Reel	Ammo
JCR05	5000	1500	1500

Packaging	Bulk (box)	Reel (JCR05)	Ammo (JCR05)
Box size (mm)	290X155X110	350X350X108	335X245X43
Carton size (mm)	310X328X250	371X371X590	515X354X258
One carton with	4 Boxes	5 Boxes (10 reels)	10 Boxes

# NTC Sensor Specialty JSR series



### Features

- RoHS / Halogen-Free (HF) compliant
- The wire length can be adjusted according to customer needs
- Operating temperature range : -40°C~+125°C
- Wide resistance range
- Qualified based on AEC-Q200
- Agency recognition : UL / TUV

- 符合RoHS / Halogen-Free (HF)規範
- 導線長度可依客戶需求調整，便於安裝
- 傳感器
- 工作溫度範圍：-40°C~+ 125°C
- 電阻範圍廣
- 符合 AEC-Q200
- 安規認證：UL / TUV

### Applications

- Home appliances
- Office automation
- Automotive
- Battery packs
- Security

- 家電
- OA 設備
- 汽車
- 電池組
- 安防設備

## How to Order

Part Number Code																						
1	2	3	4	5	6	7	8	9	10	11	12	13	14	15	16	17	18	19	20	21	22	23
J	S	R	1	0	3	F	3	4	4	F	B	2	8	0	5	0	D	B	C	A	-	X
①			②			③	④			⑤	⑥	⑦			⑧			⑨		⑩		①

①	Product Type	JSR series	⑤	Tolerance of B Value	F = ±1% G = ±2% H = ±3%	⑨	Wire Type	DB = UL4413 & Connected SB = UL4469 & Connected HF = UL3302 & Separated JB = UL4484 & Connected
②	Zero Power Resistance @25°C(R25)	502 = 5KΩ 103 = 10KΩ 474 = 470KΩ	⑥	Definition of B Value	A = 25/50 B = 25/85			
③	Tolerance of R25	F = ±1% G = ±2% H = ±3% J = ±5%	⑦	Wire Gauge	26 = 26 AWG 28 = 28 AWG 30 = 30 AWG 32 = 32 AWG	⑩	Soldered Length	DA = 2.0mm ± 0.5mm EA = 3.0mm ± 0.5mm EB = 3.0mm ± 1.0mm
④	B Value	344 = 3435 K 405 = 4050 K	⑧	Total Length	2 = 2.5 mm 4 = 3.5 mm	①	Optional Suffix	Internal Control Code

## Structure and Dimension

Unit in mm

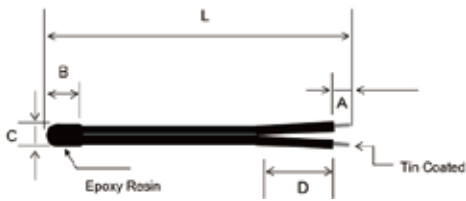

Wire Gauge	B max	C max	D min	A	L
AWG 32	6.0	2.6	10	Designed by customer needs	Designed by customer needs
AWG 30	6.0	3.0	10		
AWG 28	7.0	3.5	10		
AWG 26	8.0	4.0	10		

Wire Gauge can be designed by customer needs.

## Electrical Characteristics

Part No.	Zero Power Resistance at 25°C	Tolerance of R25	B 25/50 Value	Tolerance of B Value	Dissipation Factor	Thermal Time Constant	Max. Power Rating at 25°C	Safety Approvals
	R 25 (Ω)	(± %)	( K )	(± %)	$\delta$ (mW/°C)	$\tau$ (sec.)	(mW)	
JSR103X395YA	10,000	10,5,3,1	3950	5,3,2,1	Approx. 2.0	Approx. 10	45	■ ■
JSR103X405YA	10,000	10,5,3,1	4050	5,3,2,1	Approx. 2.0	Approx. 10	45	■
JSR103X410YA	10,000	10,5,3,1	4100	5,3,2,1	Approx. 2.0	Approx. 10	45	■ ■
JSR473X395YA	47,000	10,5,3,1	3950	5,3,2,1	Approx. 2.0	Approx. 10	45	■ ■
JSR473X405YA	47,000	10,5,3,1	4050	5,3,2,1	Approx. 2.0	Approx. 10	45	■ ■
JSR503X395YA	50,000	10,5,3,1	3950	5,3,2,1	Approx. 2.0	Approx. 10	45	■ ■
JSR104X395YB	100,000	10,5,3,1	3950	5,3,2,1	Approx. 2.0	Approx. 10	45	■ ■
JSR104X425YA	100,000	10,5,3,1	4250	5,3,2,1	Approx. 2.0	Approx. 10	45	

Part No.	Zero Power Resistance at 25°C	Tolerance of R25	B 25/85 Value	Tolerance of B Value	Dissipation Factor	Thermal Time Constant	Max. Power Rating at 25°C	Safety Approvals
	R 25 (Ω)	(± %)	( K )	(± %)	$\delta$ (mW/°C)	$\tau$ (sec.)	(mW)	
JSR103X344YB	10,000	10,5,3,1	3435	5,3,2,1	Approx. 2.0	Approx. 10	45	■ ■
JSR103X398YB	10,000	10,5,3,1	3977	5,3,2,1	Approx. 2.0	Approx. 10	45	■
JSR473X397YB	47,000	10,5,3,1	3970	5,3,2,1	Approx. 2.0	Approx. 10	45	■ ■
JSR473X408YB	47,000	10,5,3,1	4080	5,3,2,1	Approx. 2.0	Approx. 10	45	
JSR503X397YB	50,000	10,5,3,1	3970	5,3,2,1	Approx. 2.0	Approx. 10	45	■ ■
JSR683X404YB	68,000	10,5,3,1	4040	5,3,2,1	Approx. 2.0	Approx. 10	45	
JSR104X408YB	100,000	10,5,3,1	4080	5,3,2,1	Approx. 2.0	Approx. 10	45	
JSR104X419YB	100,000	10,5,3,1	4190	5,3,2,1	Approx. 2.0	Approx. 10	45	
JSR104X425YB	100,000	10,5,3,1	4250	5,3,2,1	Approx. 2.0	Approx. 10	45	■ ■
JSR104X436YB	100,000	10,5,3,1	4360	5,3,2,1	Approx. 2.0	Approx. 10	45	
JSR153X420YB	150,000	10,5,3,1	4200	5,3,2,1	Approx. 2.0	Approx. 10	45	

※ X : R Tolerance, Y : B Value Tolerance





## Reliability-NTC Thermistor JSR

Test description	Standard	Test condition	Test requirement															
Tensile Strength of Terminals	IEC 60068-2-21	Apply 0.5kg force and fix the device for 10±1 seconds.	No visible damage															
Resistance to soldering heat	IEC 60068-2-20	Terminals of lead wire are immersed in solder in bath at 260±5°C for 10±1 seconds.	$\Delta R_{25}/R_{25} \leq \pm 5\%$															
Solderability	IEC 60068-2-20	Terminals of lead wire are immersed in solder (Pb free) bath at 245±3°C for 3±0.3 seconds.	Above 95% in the terminal surface shall be with new solder															
High Temperature Storage	IEC 60068-2-2	Test sample shall be exposed in air at Tmax for 1000 hours. After being stored in room temperature and humidity for one hour.	$\Delta R_{25}/R_{25} \leq \pm 5\%$															
Damp Heat Steady State	IEC 60068-2-78	Test sample shall be exposed in 40°C, 90~95%RH for 1000 hours. After being stored in room temperature and humidity for one hour.	$\Delta R_{25}/R_{25} \leq \pm 5\%$															
Low Temperature Storage	IEC 60068-2-2	Test sample shall be exposed in air at -40°C for 1000 hours. After being stored in room temperature and humidity for one hour.	$\Delta R_{25}/R_{25} \leq \pm 5\%$															
Rapidchange of Temperature	IEC 60068-2-14	<p>Temperature cycle shall be repeated five cycles</p> <table border="1"> <thead> <tr> <th>Step</th> <th>Temperature (°C)</th> <th>Period (minutes)</th> </tr> </thead> <tbody> <tr> <td>1</td> <td>-40±5</td> <td>30±3</td> </tr> <tr> <td>2</td> <td>Room temperature</td> <td>5±3</td> </tr> <tr> <td>3</td> <td>Tmax</td> <td>30±3</td> </tr> <tr> <td>4</td> <td>Room temperature</td> <td>5±3</td> </tr> </tbody> </table> <p>After being stored in room temperature and humidity for one hour.</p>	Step	Temperature (°C)	Period (minutes)	1	-40±5	30±3	2	Room temperature	5±3	3	Tmax	30±3	4	Room temperature	5±3	$\Delta R_{25}/R_{25} \leq \pm 5\%$
Step	Temperature (°C)	Period (minutes)																
1	-40±5	30±3																
2	Room temperature	5±3																
3	Tmax	30±3																
4	Room temperature	5±3																
Life Test	IEC60539-1 4.26.3	Apply Pmax to the sample for 1000 hours at room temperature, and measure after one hour storage at room temperature and humidity	$\Delta R_{25}/R_{25} \leq \pm 5\%$															
Hi-Pot Test	IEC60539-1	Short-circuit the two wires of the product, and apply a voltage of 300Vrms (AC) between the encapsulating material and the wires at room temperature for 1.5 seconds.	No visible damage $I_{Leak} \leq 1mA$															
Insulation Resistance	MIL-STD-202F Method 302	Measured at DC 100V, the resistance must be above 100MΩ for 60± 3 seconds.	No visible damage $\geq 100M\Omega$															

# NTC Sensor Specialty JTD series



## Features

RoHS / Halogen-Free (HF) compliant

Accuracy

Operating temperature range : -40°C~+ 105°C

Wide resistance range

Agency recognition : UL / TUV

符合RoHS / Halogen-Free (HF)規範

高精度

工作溫度範圍：-40°C~+ 105°C

電阻範圍廣

安規認證：UL / TUV

## Applications

Home appliances

Mobile devices

Battery packs

Body thermometers

家電

移動設備

電池組

體溫計

## How to Order

Part Number Code																					
1	2	3	4	5	6	7	8	9	10	11	12	13	14	15	16	17	18	19	20	21	
J	T	D	1	0	3	F	3	4	4	F	B	1	2	0	8	7	N	X	X	X	
①			②			③	④			⑤		⑥	⑦		⑧			⑨	⑩	A	

①	Product Type	JTD series	⑤	Tolerance of B Value	F = ±1% G = ±2%	⑨	Coating Type	N = Black Resin
②	Zero Power Resistance @25°C(R25)	103 = 10KΩ 503 = 50KΩ 104 = 100KΩ	⑥	Definition of B Value	A = 25/50 B = 25/85	⑩	Soldered Length	X = 3.0 ± 1 mm M = 2.5 ± 1 mm
③	Tolerance of R25	F = ±1% G = ±2%	⑦	Lead Diameter	12 = Ø0.12mm 26 = Ø0.26mm Enameled wire	A	Optional Suffix	Internal Control Code
④	B Value	344 = 3435 K 398 = 3980 K	⑧	Lead Length	025 = 25 mm 087 = 87 mm			

## Structure and Dimension

Unit in mm

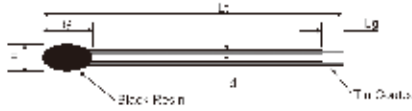

d	G max	E max	Lt ±5	Lg±1
0.08	4	0.7	40~130	3~5
0.12	4	1.4		
0.16	5	1.6		
0.26	5	1.8		

## Electrical Characteristics

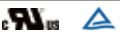
Part No.	Zero Power Resistance at 25°C	Tolerance of R25	B 25/50 Value	Tolerance of B Value	Dissipation Factor	Thermal Time Constant	Max. Power Rating at 25°C	Safety Approvals
	R 25 (Ω)	(± %)	( K )	(± %)	δ(mW/°C)	τ(sec.)	(mW)	
JTD103X338YA	10,000	10,5,3,1	3380	5,3,1	Approx. 1.6	Approx. 3.4	3.5	■
JTD103X395YA	10,000	10,5,3,1	3950	5,3,1	Approx. 1.6	Approx. 3.4	3.5	■
JTD473X395YA	47,000	10,5,3,1	3950	5,3,1	Approx. 1.6	Approx. 3.4	3.5	■ ■
JTD503X395YA	50,000	10,5,3,1	3950	5,3,1	Approx. 1.6	Approx. 3.4	3.5	■
JTD104X395XA	100,000	10,5,3,1	3950	5,3,1	Approx. 0.7	Approx. 0.8	3.5	■ ■
JTD104X425YA	100,000	10,5,3,1	4250	5,3,1	Approx. 0.7	Approx. 0.8	3.5	

Part No.	Zero Power Resistance at 25°C	Tolerance of R25	B 25/85 Value	Tolerance of B Value	Dissipation Factor	Thermal Time Constant	Max. Power Rating at 25°C	Safety Approvals
	R 25 (Ω)	(± %)	( K )	(± %)	δ(mW/°C)	τ(sec.)	(mW)	
JTD103X344YB	10,000	10,5,3,1	3435	5,3,1	Approx. 0.7	Approx. 0.8	3.5	■ ■
JTD103X398YB	10,000	10,5,3,1	3980	5,3,1	Approx. 0.7	Approx. 0.8	3.5	■
JTD104X408YB	100,000	10,5,3,1	4080	5,3,1	Approx. 0.7	Approx. 0.8	3.5	
JTD104X436YB	100,000	10,5,3,1	4360	5,3,1	Approx. 0.7	Approx. 0.8	3.5	

※ X : R Tolerance, Y : B Value Tolerance

## Reliability-NTC Thermistor JTD

Test description	Standard	Test condition	Test requirement										
Terminal pull strength	IEC 60068-2-21	<p>After gradually applying the load specified below and keeping the unit fixed for 10 ±1 sec.</p> <table border="1"> <thead> <tr> <th>Terminal diameter (mm)</th> <th>Force (Kg)</th> </tr> </thead> <tbody> <tr> <td><math>d \leq 0.25\text{mm}</math></td> <td>1N (0.102Kg)</td> </tr> <tr> <td><math>0.25\text{mm} &lt; d \leq 0.35\text{mm}</math></td> <td>2.5N (0.255Kg)</td> </tr> <tr> <td><math>0.35\text{mm} &lt; d \leq 0.50\text{mm}</math></td> <td>5N (0.510Kg)</td> </tr> <tr> <td><math>0.50\text{mm} &lt; d \leq 0.80\text{mm}</math></td> <td>10N (1.02Kg)</td> </tr> </tbody> </table>	Terminal diameter (mm)	Force (Kg)	$d \leq 0.25\text{mm}$	1N (0.102Kg)	$0.25\text{mm} < d \leq 0.35\text{mm}$	2.5N (0.255Kg)	$0.35\text{mm} < d \leq 0.50\text{mm}$	5N (0.510Kg)	$0.50\text{mm} < d \leq 0.80\text{mm}$	10N (1.02Kg)	No visible damage
Terminal diameter (mm)	Force (Kg)												
$d \leq 0.25\text{mm}$	1N (0.102Kg)												
$0.25\text{mm} < d \leq 0.35\text{mm}$	2.5N (0.255Kg)												
$0.35\text{mm} < d \leq 0.50\text{mm}$	5N (0.510Kg)												
$0.50\text{mm} < d \leq 0.80\text{mm}$	10N (1.02Kg)												
Resin coating strength	Specification Standard	The lead-wire shall be firmly wrapped on the cylinder with the diameter of 3mm. A downward tension shall be applied to the lead-wire and increased to 1N.	No visible damage										
Free fall	IEC 60068-2-32	After 3 times free fall to a maple board from 1m height.	$\Delta R_{25}/R_{25} \leq \pm 5\%$										
Damp heat	IEC 60068-2-78	Temperature $40 \pm 3^\circ\text{C}$ R.H.90~95% for 1000hours without load	$\Delta R_{25}/R_{25} \leq \pm 5\%$										
Dry heat	IEC 60068-2-2	Test sample shall be exposed in air $100^\circ\text{C} \pm 3^\circ\text{C}$ for 1000 hours. After being stored within normal room ambient temperature and humidity for 1 hour.	$\Delta R_{25}/R_{25} \leq \pm 5\%$										
Life Test	IEC 60539-1	$25 \pm 5^\circ\text{C}$ , 3.5mW, 1000hrs	$\Delta R_{25}/R_{25} \leq \pm 5\%$										
Thermal shock	IEC 60068-2-14	<p>Temperature cycling shall be proceeded in the following order and conditions.</p> <p>(a) At room ambient temperature.(initial value)</p> <p>(b) At <math>-30^\circ\text{C}</math> for 30 minutes.</p> <p>(c) At room ambient temperature for 5 minutes.</p> <p>(d) At <math>+100^\circ\text{C}</math> for 30 minutes.</p> <p>(e) At room ambient temperature for 5 minutes.</p> <p>100 cycles shall be repeated. After being stored within normal room ambient temperature and humidity for 1 hour.</p>	$\Delta R_{25}/R_{25} \leq \pm 5\%$										
Resistance to soldering heat	IEC 60068-2-20	After lead wire of test sample was one time dipped within 3.0mm from end of lead wire in solder bath at $260^\circ\text{C} \pm 5^\circ\text{C}$ for $10 \pm 1$ seconds. After being stored within normal room ambient temperature and humidity for 1 hour.	$\Delta R_{25}/R_{25} \leq \pm 5\%$										
Solderability	IEC 60068-2-20	After lead wire of test sample was one time dipped within 3.0mm from end of lead wire in solder bath at $245^\circ\text{C} \pm 3^\circ\text{C}$ for $3 \pm 0.3$ seconds. After being stored within normal room ambient temperature and humidity for 1 hour.	At least 95% of terminal electrode is covered by new solder										
Low temperature storage	IEC60068-2-1	Test sample shall be exposed in air $-40 \pm 2^\circ\text{C}$ for 1000hours. After being stored within normal room ambient temperature and humidity for 1 hour.	$\Delta R_{25}/R_{25} \leq \pm 5\%$										



# NTC Sensor Specialty JFR series



### Features

RoHS / Halogen-Free (HF) compliant

Accuracy

Operating temperature range : -40°C~+ 100°C

Agency recognition: UL / TUV

符合RoHS / Halogen-Free (HF)規範

高精度

工作溫度範圍：-40°C~+ 100°C

安規認證：UL / TUV

### Applications

IT equipment

Mobile devices

Battery packs

IT設備

移動設備

電池組

## How to Order

Part Number Code																				
1	2	3	4	5	6	7	8	9	10	11	12	13	14	15	16	17	18	19	20	
J	F	R	1	0	3	F	3	4	4	F	B	2	5	0	5	0	C	P	G	
①			②			③	④			⑤	⑥	⑦	⑧			⑨	⑩			

①	Product Type	JFR series	⑤	Tolerance of B Value	F = ±1% G = ±2%	⑨	Soldered Length	CP = 5.0mm ± 1.0 mm
②	Zero Power Resistance @25°C (R25)	103 = 10KΩ	⑥	Definition of B Value	A = 25/50 B = 25/85	⑩	Optional Suffix	Internal Control Code
③	Tolerance of R25	F = ±1% G = ±2% H = ±3% J = ±5%	⑦	Lead Diameter	25 = Ø0.25mm			
④	B Value	344 = 3435 K	⑧	Lead Length	025 = 25 mm 050 = 50 mm			

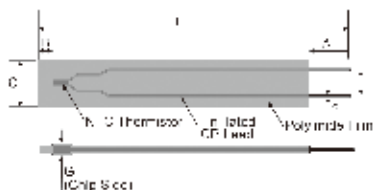

## Structure and Dimension





Unit in mm

ITEM	A±1.0	B±0.5	C±0.5	L±1.0	F±0.20	G max	d±0.02
JFR103F344FB25025CPG	5.0	2.0	4.0	25	1.55	0.6	0.25
JFR103F344FB25050CPG	5.0	2.0	4.0	50	1.55	0.6	0.25

## Electrical Characteristics

Part No.	Zero Power Resistance at 25°C	Tolerance of R25	B 25/50 Value	Tolerance of B Value	Dissipation Factor	Thermal Time Constant	Max. Power Rating at 25°C	Safety Approvals
	R 25 (Ω)	(± %)	( K )	(± %)	δ(mW/°C)	τ(sec.)	(mW)	 
JFR103X338YA	10,000	10,5,3,1	3380	5,3,1	Approx. 1.6	Approx. 3.4	3.5	
JFR103X395YA	10,000	10,5,3,1	3950	5,3,1	Approx. 1.6	Approx. 3.4	3.5	

Part No.	Zero Power Resistance at 25°C	Tolerance of R25	B 25/85 Value	Tolerance of B Value	Dissipation Factor	Thermal Time Constant	Max. Power Rating at 25°C	Safety Approvals
	R 25 (Ω)	(± %)	( K )	(± %)	δ(mW/°C)	τ(sec.)	(mW)	 
JFR103X344YB	10,000	10,5,3,1	3435	5,3,1	Approx. 1.6	Approx. 3.4	3.5	■ ■
JFR103X398YB	10,000	10,5,3,1	3980	5,3,1	Approx. 1.6	Approx. 3.4	3.5	
JFR103X405YB	10,000	10,5,3,1	3980	5,3,1	Approx. 1.6	Approx. 3.4	3.5	
JFR333X405YB	33,000	10,5,3,1	3980	5,3,1	Approx. 1.6	Approx. 3.4	3.5	

※ X : R Tolerance, Y : B Value Tolerance



## Reliability-NTC Thermistor JFR

Item	Standard	Test condition	Specifications															
Tensile Strength of Terminal	IEC 60068-2-21	<p>Gradually applying the force specified and keeping the unit fixed for 10±1 sec.</p> <table border="1"> <thead> <tr> <th>Terminal diameter (mm)</th> <th>Force (Kg)</th> </tr> </thead> <tbody> <tr> <td>d ≤ 0.25mm</td> <td>1N (0.102Kg)</td> </tr> <tr> <td>0.25mm &lt; d ≤ 0.35mm</td> <td>2.5N (0.255Kg)</td> </tr> <tr> <td>0.35mm &lt; d ≤ 0.50mm</td> <td>5N (0.510Kg)</td> </tr> <tr> <td>0.50mm &lt; d ≤ 0.80mm</td> <td>10N (1.02Kg)</td> </tr> </tbody> </table>	Terminal diameter (mm)	Force (Kg)	d ≤ 0.25mm	1N (0.102Kg)	0.25mm < d ≤ 0.35mm	2.5N (0.255Kg)	0.35mm < d ≤ 0.50mm	5N (0.510Kg)	0.50mm < d ≤ 0.80mm	10N (1.02Kg)	No visible damage					
Terminal diameter (mm)	Force (Kg)																	
d ≤ 0.25mm	1N (0.102Kg)																	
0.25mm < d ≤ 0.35mm	2.5N (0.255Kg)																	
0.35mm < d ≤ 0.50mm	5N (0.510Kg)																	
0.50mm < d ≤ 0.80mm	10N (1.02Kg)																	
Bending Strength of Terminal	IEC 60068-2-21	<p>Hold specimen and apply the force specified below to each lead. Bend the specimen to 90°, then return to original position. Repeat the procedure in the opposite direction.</p> <table border="1"> <thead> <tr> <th>Terminal diameter (mm)</th> <th>Force (Kg)</th> </tr> </thead> <tbody> <tr> <td>d ≤ 0.25mm</td> <td>0.5N (0.051Kg)</td> </tr> <tr> <td>0.25mm &lt; d ≤ 0.35mm</td> <td>1.25N (0.128Kg)</td> </tr> <tr> <td>0.35mm &lt; d ≤ 0.50mm</td> <td>2.5N (0.255Kg)</td> </tr> <tr> <td>0.50mm &lt; d ≤ 0.80mm</td> <td>5N (0.510Kg)</td> </tr> </tbody> </table>	Terminal diameter (mm)	Force (Kg)	d ≤ 0.25mm	0.5N (0.051Kg)	0.25mm < d ≤ 0.35mm	1.25N (0.128Kg)	0.35mm < d ≤ 0.50mm	2.5N (0.255Kg)	0.50mm < d ≤ 0.80mm	5N (0.510Kg)	No visible damage					
Terminal diameter (mm)	Force (Kg)																	
d ≤ 0.25mm	0.5N (0.051Kg)																	
0.25mm < d ≤ 0.35mm	1.25N (0.128Kg)																	
0.35mm < d ≤ 0.50mm	2.5N (0.255Kg)																	
0.50mm < d ≤ 0.80mm	5N (0.510Kg)																	
Solderability	IEC 60068-2-20	245±3°C, 3±0.3 sec	At least 95% of terminal electrode is covered by new solder															
Resistance to soldering heat	IEC 60068-2-20	260±3°C, 10±1 sec	△R25/R25 ≤ ±5%															
Dry heat	IEC 60068-2-2	100±5°C, 1000±24hrs	No visible damage △R25/R25 ≤ ±5%															
Damp heat, Steady State	IEC 60068-2-78	40±2°C, 90~95% RH, 1000±24hrs	No visible damage △R25/R25 ≤ ±5%															
Rapid change of temperature	IEC 60068-2-14	<p>The conditions shown below shall be repeated 5 cycles.</p> <table border="1"> <thead> <tr> <th>Step</th> <th>Temperature (°C)</th> <th>Period (minutes)</th> </tr> </thead> <tbody> <tr> <td>1</td> <td>-40±5</td> <td>30±3</td> </tr> <tr> <td>2</td> <td>Room temperature</td> <td>5±3</td> </tr> <tr> <td>3</td> <td>100±5</td> <td>30±3</td> </tr> <tr> <td>4</td> <td>Room temperature</td> <td>5±3</td> </tr> </tbody> </table>	Step	Temperature (°C)	Period (minutes)	1	-40±5	30±3	2	Room temperature	5±3	3	100±5	30±3	4	Room temperature	5±3	No visible damage △R25/R25 ≤ ±5%
Step	Temperature (°C)	Period (minutes)																
1	-40±5	30±3																
2	Room temperature	5±3																
3	100±5	30±3																
4	Room temperature	5±3																
Room temperature load	IEC 60539-1	25±5°C, Pmax, 1000±24hrs	No visible damage △R25/R25 ≤ ±5%															

## NTC Sensor Specialty JAT series



### Features

RoHS / Halogen-Free (HF) compliant  
 Operating temperature range : -40°C~+125°C  
 Wide resistance range  
 Qualified based on AEC-Q200  
 Agency recognition : UL / TUV

符合RoHS / Halogen-Free (HF)規範  
 工作溫度範圍：-40°C~+ 125°C  
 電阻範圍廣  
 符合 AEC-Q200  
 安規認證: UL / TUV

### Applications

Home appliances  
 Office automation  
 Automotive  
 Switch mode power supplies  
 Adapters  
 Security

家電  
 OA 設備  
 汽車  
 開關模式電源  
 適配器  
 安防設備

## How to Order

Part Number Code																			
1	2	3	4	5	6	7	8	9	10	11	12	13	14	15	16	17	18	19	20
J	A	T	1	0	3	F	3	4	4	F	B	5	2	0	0	1	0	3	X
①			②			③	④			⑤	⑥	⑦	⑧	⑨					

①	Product Type	JAT series	⑤	Tolerance of B Value	F = ±1% G = ±2% H = ±3% J = ±5%	⑨	Optional Suffix	Internal Control Code
②	Zero Power Resistance @25°C (R25)	502 = 5KΩ 103 = 10KΩ 474 = 470KΩ	⑥	Definition of B Value	A = 25/50 B = 25/85			
③	Tolerance of R25	F = ±1% G = ±2% H = ±3% J = ±5% K = ±10%	⑦	Lead Diameter	5 = 0.5mm			
④	B Value	344 = 3435 K 405 = 4050 K	⑧	Lead spacing	2 = 2.5mm 4 = 3.5mm			



## Structure and Dimension

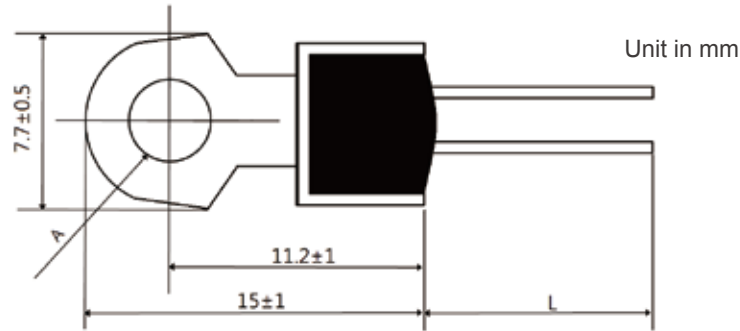

**A: 3.6mm / 4.3mm**

**L: Designed by customer needs**

## Electrical Characteristics

Part No.	Zero Power Resistance at 25°C	Tolerance of R25	B 25/50 Value	Tolerance of B Value	Dissipation Factor	Thermal Time Constant	Max. Power Rating at 25°C	Safety Approvals
	R 25 (Ω)	(± %)	( K )	(± %)	δ(mW/°C)	τ(sec.)	(mW)	
JAT103X338YA	10,000	10,5,3,2,1	3380	5,3,2,1	Approx. 2.5	Approx. 18	150	■
JAT103X410YA	10,000	10,5,3,2,1	4100	5,3,2,1	Approx. 2.5	Approx. 18	150	■
JAT473X395YA	47,000	10,5,3,2,1	3950	5,3,2,1	Approx. 2.5	Approx. 18	150	■
JAT503X395YA	50,000	10,5,3,2,1	3950	5,3,2,1	Approx. 2.5	Approx. 18	150	■
JAT104X395YA	100,000	10,5,3,2,1	3950	5,3,2,1	Approx. 2.5	Approx. 18	150	
JAT104X425YA	100,000	10,5,3,2,1	4250	5,3,2,1	Approx. 2.5	Approx. 18	150	

※ X : R Tolerance, Y : B Value Tolerance

Part No.	Zero Power Resistance at 25°C	Tolerance of R25	B 25/85 Value	Tolerance of B Value	Dissipation Factor	Thermal Time Constant	Max. Power Rating at 25°C	Safety Approvals
	R 25 (Ω)	(± %)	( K )	(± %)	δ(mW/°C)	τ(sec.)	(mW)	
JAT103X344YB	10,000	10,5,3,2,1	3435	5,3,2,1	Approx. 2.5	Approx. 18	150	■ ■
JAT103X398YB	10,000	10,5,3,2,1	3980	5,3,2,1	Approx. 2.5	Approx. 18	150	■ ■
JAT333X398YB	33,000	10,5,3,2,1	3980	5,3,2,1	Approx. 2.5	Approx. 18	150	
JAT473X409YB	47,000	10,5,3,2,1	4090	5,3,2,1	Approx. 2.5	Approx. 18	150	■
JAT503X409YB	50,000	10,5,3,2,1	4090	5,3,2,1	Approx. 2.5	Approx. 18	150	■
JAT104X395YB	100,000	10,5,3,2,1	3950	5,3,2,1	Approx. 2.5	Approx. 18	150	■
JAT104X408YB	100,000	10,5,3,2,1	4080	5,3,2,1	Approx. 2.5	Approx. 18	150	■
JAT104X419YB	100,000	10,5,3,2,1	4190	5,3,2,1	Approx. 2.5	Approx. 18	150	■
JAT104X425YB	100,000	10,5,3,2,1	4250	5,3,2,1	Approx. 2.5	Approx. 18	150	
JAT104X436YB	100,000	10,5,3,2,1	4360	5,3,2,1	Approx. 2.5	Approx. 18	150	■
JAT204X406YB	200,000	10,5,3,2,1	4055	5,3,2,1	Approx. 2.5	Approx. 18	150	■
JAT334X398YB	330,000	10,5,3,2,1	3980	5,3,2,1	Approx. 2.5	Approx. 18	150	

※ X : R Tolerance, Y : B Value Tolerance

## Reliability- NTC Sensor Specialty JAT series

Item	Standard	Test condition	Specifications															
Terminal pull strength	IEC 60068-2-21	<p>Gradually applying the force specified and keeping the unit fixed for 10±1 sec.</p> <table border="1"> <thead> <tr> <th>Terminal diameter (mm)</th> <th>Force (Kg)</th> </tr> </thead> <tbody> <tr> <td><math>d \leq 0.25\text{mm}</math></td> <td>1N (0.102Kg)</td> </tr> <tr> <td><math>0.25\text{mm} &lt; d \leq 0.35\text{mm}</math></td> <td>2.5N (0.255Kg)</td> </tr> <tr> <td><math>0.35\text{mm} &lt; d \leq 0.50\text{mm}</math></td> <td>5N (0.510Kg)</td> </tr> <tr> <td><math>0.50\text{mm} &lt; d \leq 0.80\text{mm}</math></td> <td>10N (1.02Kg)</td> </tr> </tbody> </table>	Terminal diameter (mm)	Force (Kg)	$d \leq 0.25\text{mm}$	1N (0.102Kg)	$0.25\text{mm} < d \leq 0.35\text{mm}$	2.5N (0.255Kg)	$0.35\text{mm} < d \leq 0.50\text{mm}$	5N (0.510Kg)	$0.50\text{mm} < d \leq 0.80\text{mm}$	10N (1.02Kg)	No visible damage					
Terminal diameter (mm)	Force (Kg)																	
$d \leq 0.25\text{mm}$	1N (0.102Kg)																	
$0.25\text{mm} < d \leq 0.35\text{mm}$	2.5N (0.255Kg)																	
$0.35\text{mm} < d \leq 0.50\text{mm}$	5N (0.510Kg)																	
$0.50\text{mm} < d \leq 0.80\text{mm}$	10N (1.02Kg)																	
Bending Strength of Terminals	IEC 60068-2-21	<p>Hold specimen and apply the force specified below to each lead. Bend the specimen to 90°, then return to the original position. Repeat the procedure in the opposite direction.</p> <table border="1"> <thead> <tr> <th>Terminal diameter (mm)</th> <th>Force (Kg)</th> </tr> </thead> <tbody> <tr> <td><math>d \leq 0.25\text{mm}</math></td> <td>0.5N (0.051Kg)</td> </tr> <tr> <td><math>0.25\text{mm} &lt; d \leq 0.35\text{mm}</math></td> <td>1.25N (0.128Kg)</td> </tr> <tr> <td><math>0.35\text{mm} &lt; d \leq 0.50\text{mm}</math></td> <td>2.5N (0.255Kg)</td> </tr> <tr> <td><math>0.50\text{mm} &lt; d \leq 0.80\text{mm}</math></td> <td>5N (0.510Kg)</td> </tr> </tbody> </table>	Terminal diameter (mm)	Force (Kg)	$d \leq 0.25\text{mm}$	0.5N (0.051Kg)	$0.25\text{mm} < d \leq 0.35\text{mm}$	1.25N (0.128Kg)	$0.35\text{mm} < d \leq 0.50\text{mm}$	2.5N (0.255Kg)	$0.50\text{mm} < d \leq 0.80\text{mm}$	5N (0.510Kg)	No visible damage					
Terminal diameter (mm)	Force (Kg)																	
$d \leq 0.25\text{mm}$	0.5N (0.051Kg)																	
$0.25\text{mm} < d \leq 0.35\text{mm}$	1.25N (0.128Kg)																	
$0.35\text{mm} < d \leq 0.50\text{mm}$	2.5N (0.255Kg)																	
$0.50\text{mm} < d \leq 0.80\text{mm}$	5N (0.510Kg)																	
Solderability	IEC 60068-2-20	245±3°C, 3±0.3 sec	At least 95% of terminal electrode is covered by new solder															
Resistance to soldering heat	IEC 60068-2-20	260±5°C, 10±1 sec	No visible damage △R25/R25 ≤ ±5%															
High temperature storage	IEC 60068-2-2	125±2°C, 1000hrs	No visible damage △R25/R25 ≤ ±5%															
Damp Heat Steady State	IEC 60068-2-78	40±2°C, 90~95% RH, 1000±24hrs	No visible damage △R25/R25 ≤ ±5%															
Rapid Change of Temperature	IEC 60068-2-14	<p>The conditions shown below shall be repeated 5 cycles.</p> <table border="1"> <thead> <tr> <th>Step</th> <th>Temperature (°C)</th> <th>Period (minutes)</th> </tr> </thead> <tbody> <tr> <td>1</td> <td>-40±5</td> <td>30±3</td> </tr> <tr> <td>2</td> <td>Room temperature</td> <td>5±3</td> </tr> <tr> <td>3</td> <td>125±5</td> <td>30±3</td> </tr> <tr> <td>4</td> <td>Room temperature</td> <td>5±3</td> </tr> </tbody> </table>	Step	Temperature (°C)	Period (minutes)	1	-40±5	30±3	2	Room temperature	5±3	3	125±5	30±3	4	Room temperature	5±3	No visible damage △R25/R25 ≤ ±5%
Step	Temperature (°C)	Period (minutes)																
1	-40±5	30±3																
2	Room temperature	5±3																
3	125±5	30±3																
4	Room temperature	5±3																
Life Test	IEC 60539-1 4.26.3	25±5°C, Pmax, 1000hrs	No visible damage △R25/R25 ≤ ±5%															



# NTC Sensor Specialty JAS series



### Features

RoHS / Halogen-Free (HF) compliant  
 Operating temperature range : -40°C~+125°C  
 Wide resistance range  
 Agency recognition: UL / TUV

符合RoHS / Halogen-Free (HF)規範  
 工作溫度範圍：-40°C~+ 125°C  
 電阻範圍廣  
 安規認證: UL / TUV

### Applications

Home appliances  
 Office automation  
 Automotive  
 Switch mode power supplies  
 Adapters  
 Security

家電  
 OA 設備  
 汽車  
 開關模式電源  
 適配器  
 安防設備

## How to Order

Part Number Code																			
1	2	3	4	5	6	7	8	9	10	11	12	13	14	15	16	17	18	19	20
J	A	S	1	0	3	F	3	4	4	F	B	2	8	0	0	1	0	B	X
①			②			③	④			⑤	⑥	⑦		⑧					

①	Product Type	JAT series	⑤	Tolerance of B Value	F = ±1% G = ±2% H = ±3% J = ±5%
②	Zero Power Resistance @25°C (R25)	502 = 5KΩ 103 = 10KΩ 474 = 470KΩ	⑥	Definition of B Value	A = 25/50 B = 25/85
③	Tolerance of R25	F = ±1% G = ±2% H = ±3% J = ±5% K = ±10%	⑦	Lead Diameter	26 = 26 AWG 28 = 28AWG 30 = 30AWG
④	B Value	344 = 3435 K 405 = 4050 K 425 = 4250 K	⑧	Optional Suffix	Internal Control Code

## Structure and Dimension (Terminal Lug type)



① 感測頭 (Lug)	② 導線 (Lead)	③ 導線末端加工 (connector)
感測頭樣式可依客戶需求變更 常用感測頭型式如下圖 Lug can be designed by customer needs. Please refer the Lug type as below.	導線長度 / 規格可依客戶需求調整 Lead length / type can be designed by customer needs.	可依客戶需求加裝連接器 Connector can be added by customer needs.

## 感測頭樣式參考 (Lug type reference)

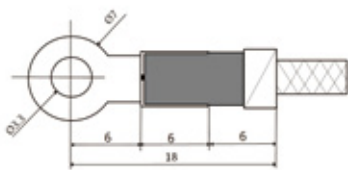

type A

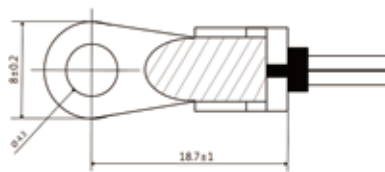

type B

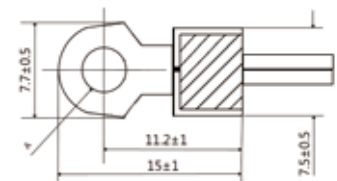

type C

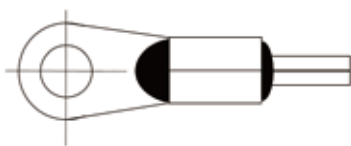

type D

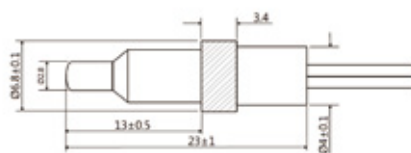

type E

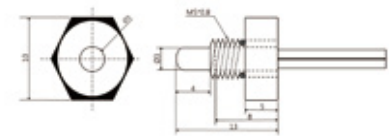

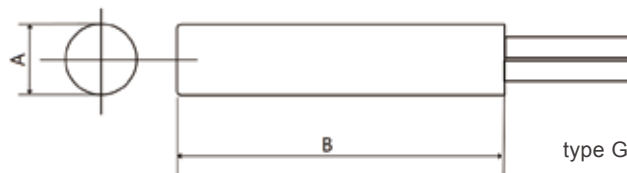

type F





type G

材質 Material	尺寸 Dimension
鍍鎳銅殼 (Nickel-plated copper shell)	A: Ø 4.0mm, 5.0mm
SUS 不鏽鋼殼 (Stainless steel shell)	B: 20mm, 25mm, 30mm
ABS塑膠 (ABS)	

## Electrical Characteristics

Part No.	Zero Power Resistance at 25°C	Tolerance of R25	B 25/50 Value	Tolerance of B Value	Dissipation Factor	Thermal Time Constant	Max. Power Rating at 25°C	Safety Approvals
	R 25 (Ω)	(± %)	( K )	(± %)	δ(mW/°C)	τ(sec.)	(mW)	 
JAS103X395YA	10,000	10,5,3,1	3950	5,3,2,1	Approx. 2.0	Approx. 10	45	■
JAS103X405YA	10,000	10,5,3,1	4050	5,3,2,1	Approx. 2.0	Approx. 10	45	■
JAS103X410YA	10,000	10,5,3,1	4100	5,3,2,1	Approx. 2.0	Approx. 10	45	■
JAS473X395YA	47,000	10,5,3,1	3950	5,3,2,1	Approx. 2.0	Approx. 10	45	■
JAS473X405YA	47,000	10,5,3,1	4050	5,3,2,1	Approx. 2.0	Approx. 10	45	■
JAS503X395YA	50,000	10,5,3,1	3950	5,3,2,1	Approx. 2.0	Approx. 10	45	■
JAS104X395YA	100,000	10,5,3,1	3950	5,3,2,1	Approx. 2.0	Approx. 10	45	■
JAS104X425YA	100,000	10,5,3,1	4250	5,3,2,1	Approx. 2.0	Approx. 10	45	

Part No.	Zero Power Resistance at 25°C	Tolerance of R25	B 25/85 Value	Tolerance of B Value	Dissipation Factor	Thermal Time Constant	Max. Power Rating at 25°C	Safety Approvals
	R 25 (Ω)	(± %)	( K )	(± %)	δ(mW/°C)	τ(sec.)	(mW)	 
JAS103X344YB	10,000	10,5,3,1	3435	5,3,2,1	Approx. 2.0	Approx. 10	45	■ ■
JAS103X398YB	10,000	10,5,3,1	3977	5,3,2,1	Approx. 2.0	Approx. 10	45	■
JAS333X398YB	33,000	10,5,3,1	3980	5,3,2,1	Approx. 2.0	Approx. 10	45	
JAS473X397YB	47,000	10,5,3,1	3970	5,3,2,1	Approx. 2.0	Approx. 10	45	■
JAS473X408YB	47,000	10,5,3,1	4080	5,3,2,1	Approx. 2.0	Approx. 10	45	
JAS503X397YB	50,000	10,5,3,1	3970	5,3,2,1	Approx. 2.0	Approx. 10	45	■
JAS683X404YB	68,000	10,5,3,1	4040	5,3,2,1	Approx. 2.0	Approx. 10	45	
JAS104X408YB	100,000	10,5,3,1	4080	5,3,2,1	Approx. 2.0	Approx. 10	45	
JAS104X419YB	100,000	10,5,3,1	4190	5,3,2,1	Approx. 2.0	Approx. 10	45	
JAS104X425YB	100,000	10,5,3,1	4250	5,3,2,1	Approx. 2.0	Approx. 10	45	■
JAS104X436YB	100,000	10,5,3,1	4360	5,3,2,1	Approx. 2.0	Approx. 10	45	
JAS153X420YB	150,000	10,5,3,1	4200	5,3,2,1	Approx. 2.0	Approx. 10	45	

※ X : R Tolerance, Y : B Value Tolerance

## Reliability- NTC Sensor Specialty JAS series

Test description	Standard	Test condition	Test requirement															
Tensile Strength of Terminals	IEC 60068-2-21	Apply 0.5kg force and fix the device for 10±1 seconds.	No visible damage															
Resistance to soldering heat	IEC 60068-2-20	Terminals of lead wire are immersed in solder in bath at 260±5°C for 10±1 seconds.	$\Delta R_{25}/R_{25} \leq \pm 5\%$															
Solderability	IEC 60068-2-20	Terminals of lead wire are immersed in solder (Pb free) bath at 245±3°C for 3±0.3 seconds.	Above 95% in the terminal surface shall be with new solder															
High Temperature Storage	IEC 60068-2-2	Test sample shall be exposed in air at Tmax for 1000 hours. After being stored in room temperature and humidity for one hour.	$\Delta R_{25}/R_{25} \leq \pm 5\%$															
Damp Heat Steady State	IEC 60068-2-78	Test sample shall be exposed in 40°C, 90~95%RH for 1000 hours. After being stored in room temperature and humidity for one hour.	$\Delta R_{25}/R_{25} \leq \pm 5\%$															
Low Temperature Storage	IEC 60068-2-2	Test sample shall be exposed in air at -40°C for 1000 hours. After being stored in room temperature and humidity for one hour.	$\Delta R_{25}/R_{25} \leq \pm 5\%$															
Rapidchange of Temperature	IEC 60068-2-14	<p>Temperature cycle shall be repeated five cycles</p> <table border="1"> <thead> <tr> <th>Step</th> <th>Temperature (°C)</th> <th>Period (minutes)</th> </tr> </thead> <tbody> <tr> <td>1</td> <td>-40±5</td> <td>30±3</td> </tr> <tr> <td>2</td> <td>Room temperature</td> <td>5±3</td> </tr> <tr> <td>3</td> <td>Tmax</td> <td>30±3</td> </tr> <tr> <td>4</td> <td>Room temperature</td> <td>5±3</td> </tr> </tbody> </table> <p>After being stored in room temperature and humidity for one hour.</p>	Step	Temperature (°C)	Period (minutes)	1	-40±5	30±3	2	Room temperature	5±3	3	Tmax	30±3	4	Room temperature	5±3	$\Delta R_{25}/R_{25} \leq \pm 5\%$
Step	Temperature (°C)	Period (minutes)																
1	-40±5	30±3																
2	Room temperature	5±3																
3	Tmax	30±3																
4	Room temperature	5±3																
Life Test	IEC60539-1 4.26.3	Apply Pmax to the sample for 1000 hours at room temperature, and measure after one hour storage at room temperature and humidity	$\Delta R_{25}/R_{25} \leq \pm 5\%$															
Hi-Pot Test	IEC60539-1	Short-circuit the two wires of the product, and apply a voltage of 300Vrms (AC) between the encapsulating material and the wires at room temperature for 1.5 seconds.	No visible damage $I_{Leak} \leq 1mA$															
Insulation Resistance	MIL-STD-202F Method 302	Measured at DC 100V The resistance must be above 100MΩ for 60± 3 sec	No visible damage $\geq 100M\Omega$															

## NTC SMD JSN series



### Features

RoHS / Halogen-Free (HF) compliant  
 Highly reliable structure  
 Operating temperature range : -40°C ~ + 125°C  
 Qualified based on AEC-Q200  
 Agency recognition : UL / TUV

符合RoHS / Halogen-Free (HF)規範  
 高精度  
 工作溫度範圍：-40°C ~ + 125°C  
 符合 AEC-Q200  
 安規認證：UL / TUV

### Applications

IT equipment  
 Mobile devices  
 Battery packs  
 Office automation equipment  
 Automotive

IT設備  
 移動設備  
 電池組  
 OA設備  
 汽車

## How to Order

Part Number Code															
1	2	3	4	5	6	7	8	9	10	11	12	13	14	15	16
J	S	N	A	1	0	3	F	3	4	4	F	B	B	X	G
①			②	③			④	⑤			⑥	⑦	⑧		

①	Product Type	JSN series	⑤	B Value	344 = 3435 K 405 = 4050 K
②	Size	Z = 0201 (0603) A = 0402 (1005) B = 0603 (1608) C = 0805 (2012)	⑥	Tolerance of B Value	F = ±1% G = ±2% H = ±3% J = ±5%
③	Zero Power Resistance @25°C (R25)	502 = 5KΩ 103 = 10KΩ 104 = 100KΩ	⑦	Definition of B Value	A = 25/50 B = 25/85
④	Tolerance of R25	F = ±1% G = ±2% H = ±3% J = ±5% K = ±10%	⑧	Optional Suffix	Internal Control Code



## Structure and Dimension

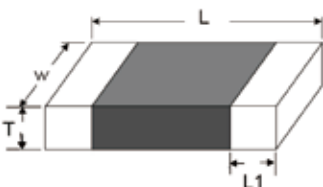

Unit in mm



Size	L	W	T	L1
JSNZ(0201)	0.60±0.05	0.30±0.05	0.30 Max	0.15±0.05
JSNA(0402)	1.00±0.15	0.50±0.15	0.65 Max	0.25±0.10
JSNB(0603)	1.60±0.15	0.80±0.15	1.00 Max	0.30±0.20
JSNC(0805)	2.00±0.20	1.25±0.20	1.10 Max	0.50±0.30

## Electrical Characteristics

Part No.	Zero Power Resistance at 25°C	Tolerance of R25	B 25/50 Value	Tolerance of B Value	Dissipation Factor	Thermal Time Constant	Max. Power Rating at 25°C	Safety Approvals
	R 25 (Ω)	(± %)	( K )	(± %)	$\delta$ (mW/°C)	$\tau$ (sec.)	(mW)	 
JSNZ103X338YA	10,000	10,5,3,2,1	3380	5,3,2,1	Approx. 1.0	Approx. 3.0	100	
JSNZ473X405YA	47,000	10,5,3,2,1	4050	5,3,2,1	Approx. 1.0	Approx. 3.0	100	
JSNZ104X425YA	100,000	10,5,3,2,1	4250	5,3,2,1	Approx. 1.0	Approx. 3.0	100	
JSNZ474X395YA	470,000	10,5,3,2,1	3950	5,3,2,1	Approx. 1.0	Approx. 3.0	100	
JSNA103X338YA	10,000	10,5,3,2,1	3380	5,3,2,1	Approx. 1.7	Approx. 3.0	170	■
JSNA104X425YA	100,000	10,5,3,2,1	4250	5,3,2,1	Approx. 1.7	Approx. 3.0	170	■
JSNB103X338YA	10,000	10,5,3,2,1	3380	5,3,2,1	Approx. 2.1	Approx. 3.1	210	■
JSNB104X420YA	100,000	10,5,3,2,1	4200	5,3,2,1	Approx. 2.1	Approx. 3.1	210	■
JSNB104X425YA	100,000	10,5,3,2,1	4250	5,3,2,1	Approx. 2.1	Approx. 3.1	210	■
JSNC103X338YA	10,000	10,5,3,2,1	3380	5,3,2,1	Approx. 1.7	Approx. 3.0	170	■
JSNC104X425YA	100,000	10,5,3,2,1	4250	5,3,2,1	Approx. 1.7	Approx. 3.0	170	■

Part No.	Zero Power Resistance at 25°C	Tolerance of R25	B 25/85 Value	Tolerance of B Value	Dissipation Factor	Thermal Time Constant	Max. Power Rating at 25°C	Safety Approvals
	R 25 (Ω)	(± %)	( K )	(± %)	$\delta$ (mW/°C)	$\tau$ (sec.)	(mW)	 
JSNZ103X344YB	10,000	10,5,3,2,1	3435	5,3,2,1	Approx. 1.0	Approx. 3.0	100	
JSNZ474X405YB	470,000	10,5,3,2,1	4050	5,3,2,1	Approx. 1.0	Approx. 3.0	100	
JSNA103X344YB	10,000	10,5,3,2,1	3435	5,3,2,1	Approx. 1.7	Approx. 3.0	170	■ ■
JSNA473X405YB	47,000	10,5,3,2,1	4050	5,3,2,1	Approx. 1.7	Approx. 3.0	170	■
JSNA104X405YB	100,000	10,5,3,2,1	4050	5,3,2,1	Approx. 1.7	Approx. 3.0	170	■
JSNA104X431YB	100,000	10,5,3,2,1	4310	5,3,2,1	Approx. 1.7	Approx. 3.0	170	■
JSNB682X344YB	6,800	10,5,3,2,1	3435	5,3,2,1	Approx. 2.1	Approx. 3.1	210	■
JSNB103X344YB	10,000	10,5,3,2,1	3435	5,3,2,1	Approx. 2.1	Approx. 3.1	210	■ ■
JSNB103X397YB	10,000	10,5,3,2,1	3970	5,3,2,1	Approx. 2.1	Approx. 3.1	210	■
JSNB473X395YB	47,000	10,5,3,2,1	3950	5,3,2,1	Approx. 2.1	Approx. 3.1	210	■ ■
JSNB473X405YB	47,000	10,5,3,2,1	4050	5,3,2,1	Approx. 2.1	Approx. 3.1	210	■
JSNB503X395YB	50,000	10,5,3,2,1	3950	5,3,2,1	Approx. 2.1	Approx. 3.1	210	■
JSNB104X395YB	100,000	10,5,3,2,1	3950	5,3,2,1	Approx. 2.1	Approx. 3.1	210	■
JSNB104X405YB	100,000	10,5,3,2,1	4050	5,3,2,1	Approx. 2.1	Approx. 3.1	210	■
JSNB104X436YB	100,000	10,5,3,2,1	4360	5,3,2,1	Approx. 2.1	Approx. 3.1	210	■
JSNB104X440YB	100,000	10,5,3,2,1	4400	5,3,2,1	Approx. 2.1	Approx. 3.1	210	■
JSNB204X406YB	200,000	10,5,3,2,1	4055	5,3,2,1	Approx. 2.1	Approx. 3.1	210	■ ■
JSNC502X344YB	5,000	10,5,3,2,1	3435	5,3,2,1	Approx. 2.4	Approx. 7.5	240	■
JSNC682X344YB	6,800	10,5,3,2,1	3435	5,3,2,1	Approx. 2.4	Approx. 7.5	240	
JSNC103X344YB	10,000	10,5,3,2,1	3435	5,3,2,1	Approx. 2.4	Approx. 7.5	240	■
JSNC473X400YB	47,000	10,5,3,2,1	4000	5,3,2,1	Approx. 2.4	Approx. 7.5	240	■
JSNC503X400YB	50,000	10,5,3,2,1	4000	5,3,2,1	Approx. 2.4	Approx. 7.5	240	■
JSNC683X400YB	68,000	10,5,3,2,1	4000	5,3,2,1	Approx. 2.4	Approx. 7.5	240	■ ■
JSNC104X398YB	100,000	10,5,3,2,1	3980	5,3,2,1	Approx. 2.4	Approx. 7.5	240	■ ■
JSNC104X400YB	100,000	10,5,3,2,1	4000	5,3,2,1	Approx. 2.4	Approx. 7.5	240	■ ■
JSNC204X395YB	200,000	10,5,3,2,1	3950	5,3,2,1	Approx. 2.4	Approx. 7.5	240	■

※ X : R Tolerance, Y : B Value Tolerance





## Reliability-SMD Type NTC Thermistor for Temperature Sensing (JSN)

Item	Standard	Test condition	Specifications															
Bending strength	IEC 60068-2-21	Speed <0.5mm/sec Duration : 10sec on PCB Warp : 2mm	No visible damage $\Delta R_{25}/R_{25} \leq \pm 5\%$															
Solderability	IEC 60068-2-58	245±5°C , 3±0.3 sec.	Above 95% in the terminal surface shall be with new solder															
Resistance to soldering heat	IEC 60068-2-58	260±5°C , 10±1 sec.	No visible damage $\Delta R_{25}/R_{25} \leq \pm 5\%$															
High temperature storage	IEC 60068-2-2	125±5°C , 1000±24 hrs.	No visible damage $\Delta R_{25}/R_{25} \leq \pm 5\%$															
Damp Heat, Steady State	IEC 60068-2-78	40±2°C , 90~95%RH , 1000±24 hrs.	No visible damage $\Delta R_{25}/R_{25} \leq \pm 5\%$															
Rapid Change of temperature	IEC 60068-2-14	Temperature cycle shall be repeated 5 cycles on PCB <table border="1" style="margin-left: auto; margin-right: auto;"> <thead> <tr> <th>Step</th> <th>Temperature (°C)</th> <th>Period (minutes)</th> </tr> </thead> <tbody> <tr> <td>1</td> <td>-40±5</td> <td>30±3</td> </tr> <tr> <td>2</td> <td>Room temperature</td> <td>5±3</td> </tr> <tr> <td>3</td> <td>125±5</td> <td>30±3</td> </tr> <tr> <td>4</td> <td>Room temperature</td> <td>5±3</td> </tr> </tbody> </table>	Step	Temperature (°C)	Period (minutes)	1	-40±5	30±3	2	Room temperature	5±3	3	125±5	30±3	4	Room temperature	5±3	No visible damage $\Delta R_{25}/R_{25} \leq \pm 5\%$
Step	Temperature (°C)	Period (minutes)																
1	-40±5	30±3																
2	Room temperature	5±3																
3	125±5	30±3																
4	Room temperature	5±3																
Max. Power Dissipation	IEC 60539-1 4.26.3	25±5°C , Pmax , 1000±24 hrs.	No visible damage $\Delta R_{25}/R_{25} \leq \pm 5\%$															

## Packing

### Taping Specification

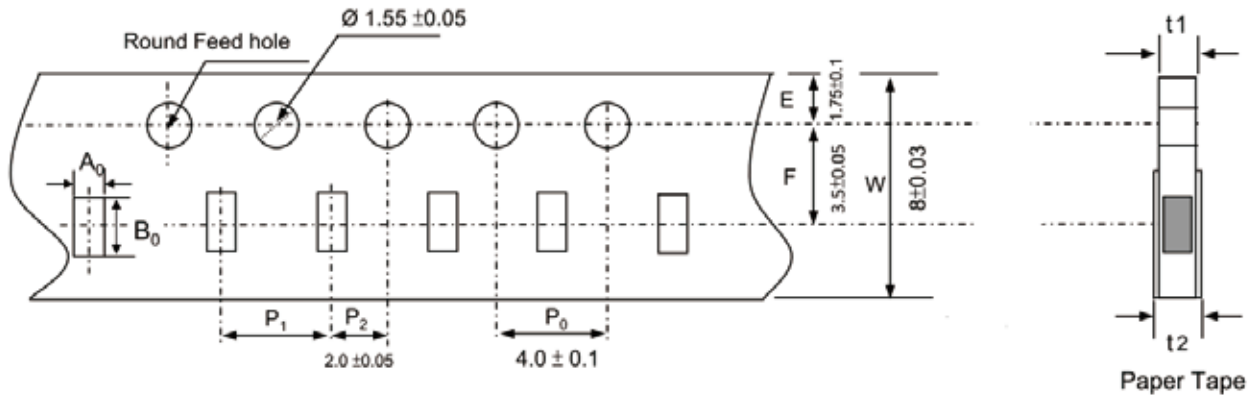

### Dimension of Paper Tape

Size	A0 ±0.1 (mm)	B0 ±0.1 (mm)	P1 ±0.1 (mm)	t1 / t2 (mm)	Quantity / Reel(Pcs)
JSNZ (0201)	0.38	0.68	2	t2 ≤ 0.5	15000
JSNA (0402)	0.65	1.15	4	1.0max / 1.1max	10000
JSNB (0603)	1.10	1.90	4	1.0max / 1.1max	4000
JSNC (0805)	1.50	2.35	4	1.0max / 1.1max	4000

### Reel Specification

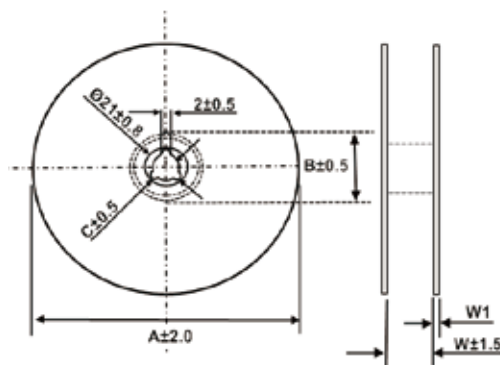

Unit in mm

Size	A	B	C	W	W <sub>1</sub>
JSNZ (0201)	178	60	13	10	1.6
JSNA (0402)	178	60	13	10	1.6
JSNB (0603)	178	60	13	10	1.6
JSNC (0805)	178	60	13	10	1.6





## Headquarters

久尹股份有限公司

JOYIN CO., LTD.

326007桃園市楊梅區蚩蚩路623巷160號

No.160, Ln. 623, Shenshen Rd., Yangmei Dist.,

Taoyuan City 326007, Taiwan

Tel : +886-3-475-5094

Fax: +886-3-475-6835

E-mail:sales@joyin.com.tw

<http://www.joyin.com.tw>

東莞久尹電子有限公司

DONGGUAN JOYIN ELECTRONICS CO., LTD.

523077中國廣東省東莞市南城區周溪環博將軍路9號

No. 9, Jiang- Jun Road, Huan Bo, Zhou Xi,

Nan-Cheng District, Dongguan , Guangdong Province,

China 523077

Tel : +86-769-2240-2759

Fax: +86-769-2240-4831

久尹科技(蘇州)有限公司

JOYIN TECHNOLOGY (SUZHOU) CO., LTD.

215009江蘇省蘇州市新區寶帶西路1566號

新銳科創中心2號樓901-902室

Room 901-902, Building 2, Xinrui Kechuang Center,

No. 1566 Baodai West Road, Huqiu District,

Suzhou City, Jiangsu Province, China 215009

Tel : +86-512-6808-6599

Fax: +86-512-6808-6099